



> PRINT > COPY > SCAN > FAX

ECOSYS M5521cdn  
ECOSYS M5521cdw

# FIRST STEPS QUICK GUIDE



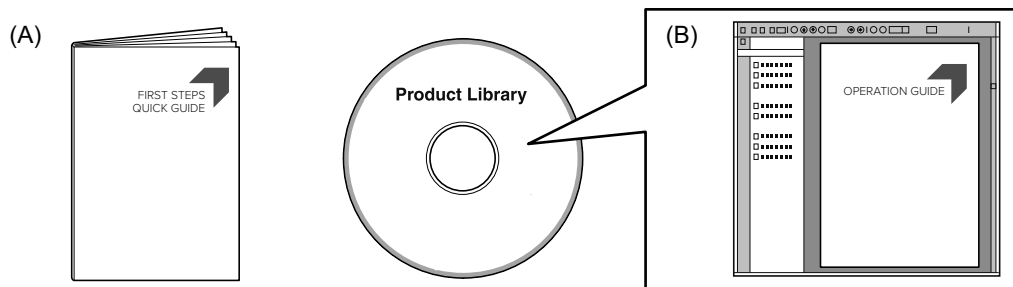

- EN** This guide (A) only explains the basic operations of the machine.  
For other information, see Operation Guide (B) on the Product Library disc.
- CA** En aquesta guia (A) només es descriuen les operacions bàsiques de la màquina. Per obtenir més informació, consulteu la Guia de Funcionament (B) al disc Biblioteca del producte (Product Library).
- CS** Tento průvodce (A) vysvětluje pouze základní obsluhu zařízení.  
Bližší informace naleznete v Návodu k obsluze (B) na disku Product Library.
- DA** Denne vejledning (A) forklarer kun de grundlæggende funktioner af maskinen.  
Andre oplysninger findes i Betjeningsvejledning (B) på Product Library disken.
- DE** Dieser Leitfaden (A) erläutert nur die grundlegende Bedienung des Geräts.  
Für weitere Informationen, siehe Bedienungsanleitung (B) in der Product Library auf dem Datenträger.
- EL** Οι παρούσες οδηγίες (A) επεξηγούν μόνο τις βασικές λειτουργίες του μηχανήματος.  
Για άλλες πληροφορίες, ανατρέξτε στις Οδηγίες χρήσης (B) στο δίσκο Product Library.
- ES** En esta guía (A) solo se explican los procedimientos básicos de la máquina.  
Para obtener otra información, consulte la Guía de uso (B) en el disco Product Library.
- FI** Tässä oppaassa (A) kuvataan vain laitteen perustoiminnot.  
Katso tarkemmat tiedot Product Library -levyn Käyttöopas (B).
- FR** Ce guide (A) explique uniquement les opérations de base de la machine.  
Pour toute autre information, se reporter au Manuel d'utilisation (B) sur le disque Product Library.
- HU** Ez az útmutató (A) csak a készülék alapvető működését ismerteti.  
Bővebb információért lásd a Használati útmutatót (B) a Product Library lemezen.
- IT** Questa guida (A) descrive solo le funzioni base del dispositivo.  
Per ulteriori informazioni, vedere la Guida alle funzioni (B) sul disco Product Library.
- NL** In deze handleiding (A) worden alleen de basisfuncties van de machine beschreven.  
Voor meer informatie, raadpleeg de gebruikershandleiding (B) op de Product Library schijf.
- NO** Denne guide (A) forklarer bare den grunnleggende bruken av maskinen.  
For annen informasjon, se Operatørhåndbok (B) i Product Library platen.

**PL** Niniejszy podręcznik (A) objaśnia jedynie podstawowe sposoby używania urządzenia.  
Więcej informacji można znaleźć w Podręczniku Obsługi (B) lub na dysku Product Library.

**PT-BR** Este guia (A) somente explica as operações básicas da máquina.  
Para obter outras informações, consulte o Guia de Operação (B) no disco Product Library.

**PT-PT** Este guia (A) explica apenas as operações básicas da máquina.  
Para obter mais informações, consulte o Guia de Operação (B) no disco Product Library.

**RO** Acest ghid (A) explică doar operațiunile de bază ale aparatului.  
Pentru alte informații, consultați Ghidul de Operare (B) de pe discul Product Library.

**RU** В данном руководстве (A) описаны только основные операции с устройством.  
Дополнительные сведения см. в руководстве по эксплуатации (B) на диске Product Library.

**SV** I den här guiden (A) förklaras endast maskinens grundfunktioner.  
För annan information hänvisas till bruksanvisningen (B) på skivan Product Library.

**TR** Bu kılavuz (A) sadece makinenin temel işlemlerini açıklar.  
Diğer bilgiler için, Product Library diskindeki Çalıştırma Kılavuzuna (B) bakınız.

**AR** هذا الدليل (A) يشرح فقط عمليات تشغيل الجهاز الأساسية.  
لمزيد من المعلومات، راجع دليل التشغيل (B) الموجود على قرص Product Library.

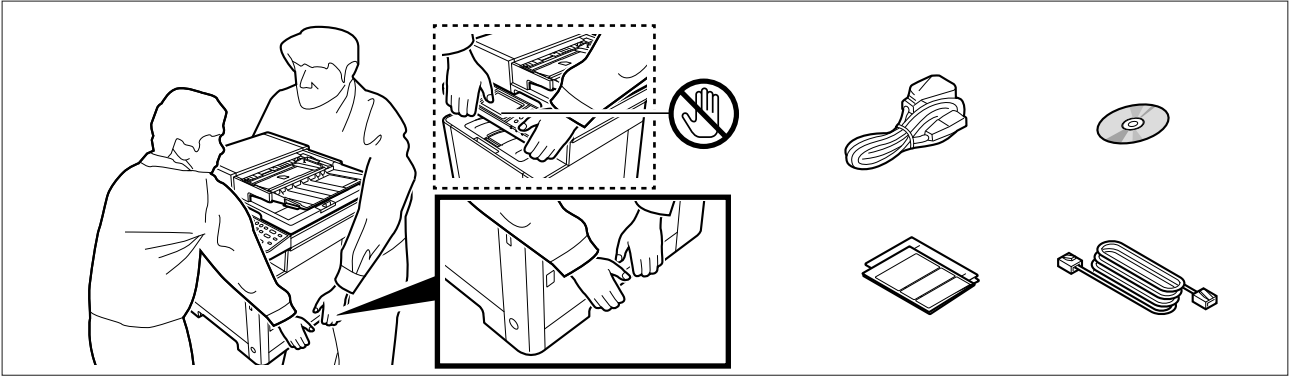

- (EN) The included components differ depending on the countries or regions.
- (CA) Els components que s'hi inclouen poden variar en funció dels països o de les regions.
- (CS) Přiložené součásti se mohou lišit v závislosti na zemích nebo oblastech.
- (DA) De medfølgende komponenter varierer afhængigt af land eller region.
- (DE) Je nach Land oder Region sind im Lieferumfang andere Komponenten enthalten.
- (EL) Τα εξαρτήματα που περιλαμβάνονται ενδέχεται να διαφέρουν ανάλογα με τη χώρα ή την περιοχή.
- (ES) Los componentes facilitados varían en función de los países o regiones.
- (FI) Pakkaukseen kuuluvat osat vaihtelevat maan ja alueen mukaan.
- (FR) Les composants inclus varient en fonction des pays ou régions.
- (HU) A mellékelt alkatrészek országtól vagy régiótól függően változók.
- (IT) I componenti inclusi sono differenti a seconda del paese o della zona geografica.
- (NL) De meegeleverde onderdelen verschillen volgens het land of de regio.
- (NO) De medfølgende komponentene varierer avhengig av land eller region.
- (PL) Dołączone do urządzenia wyposażenie może różnić się w zależności od kraju lub regionu.
- (PT-BR) Os componentes incluídos variam conforme os países ou as regiões.
- (PT-PT) Os componentes incluídos variam consoante os países ou regiões.
- (RO) Componentele incluse diferă în funcție de țară sau regiune.
- (RU) Комплектация компонентами зависит от страны или региона.
- (SV) De medföljande komponenterna varierar i olika länder och regioner.
- (TR) Ürünle birlikte verilen parçalar ülkeye veya bölgeye göre değişir.
- (AR) تختلف المكونات المضمنة باختلاف البلاد أو المناطق.

## C Setting up the Toner Container

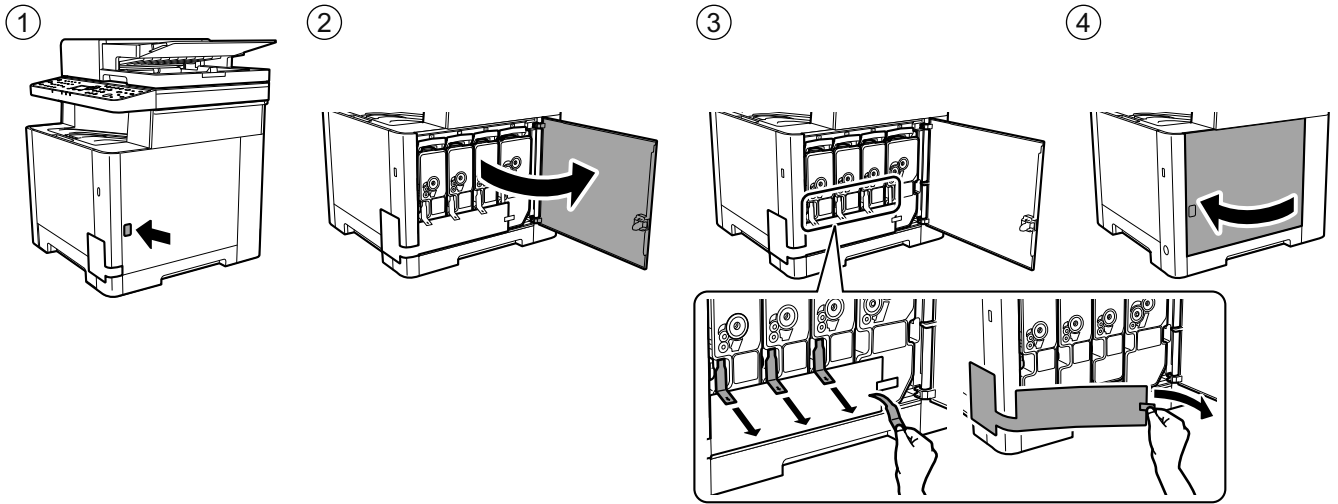

## D Connect Cable

### Network

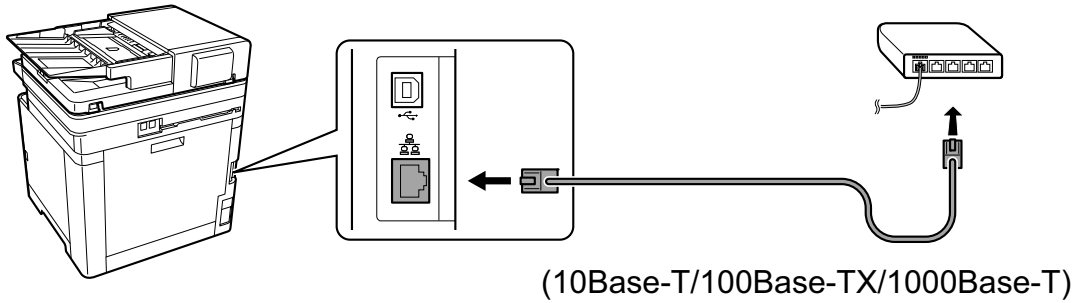

### USB

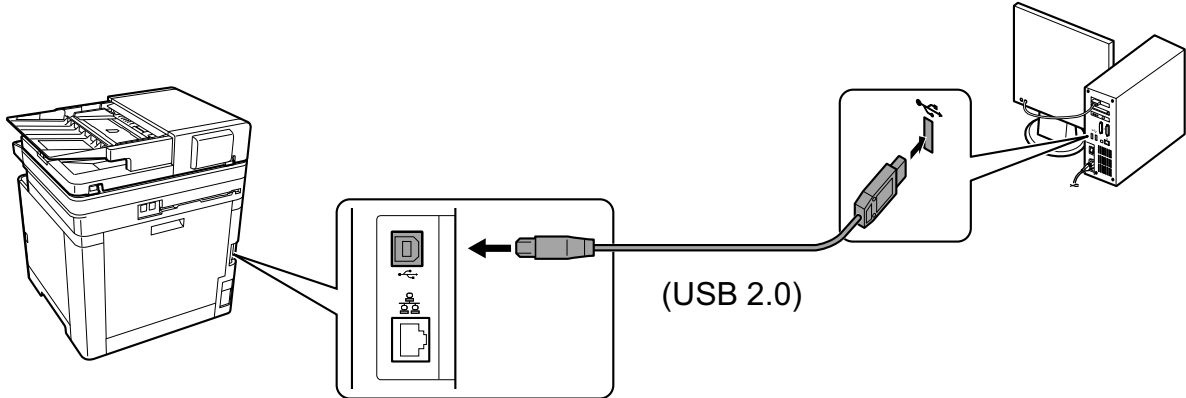

### FAX

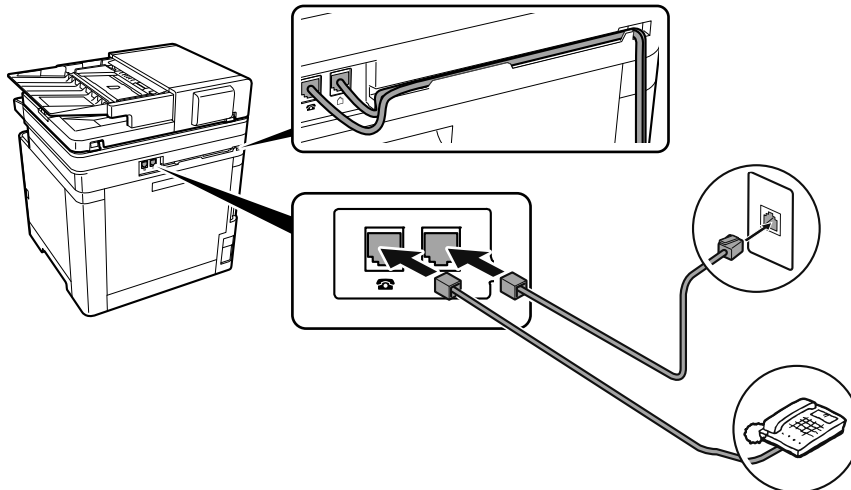

## E Loading Paper

①

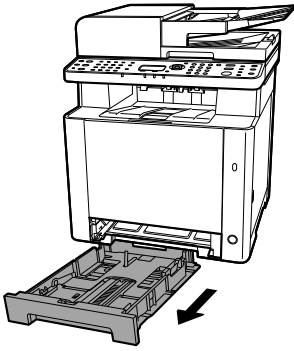

②

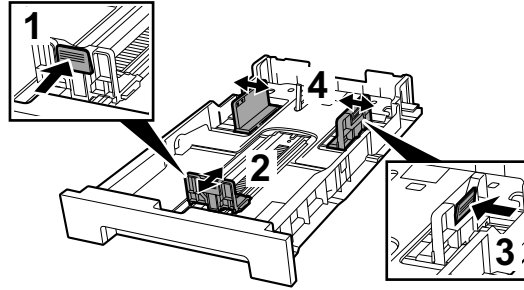

③

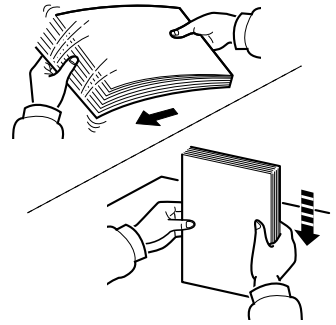

④

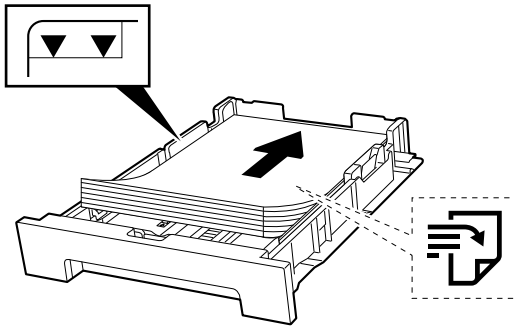

⑤

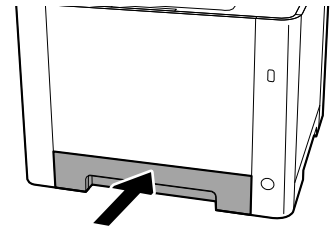

## F Connect Power Cord

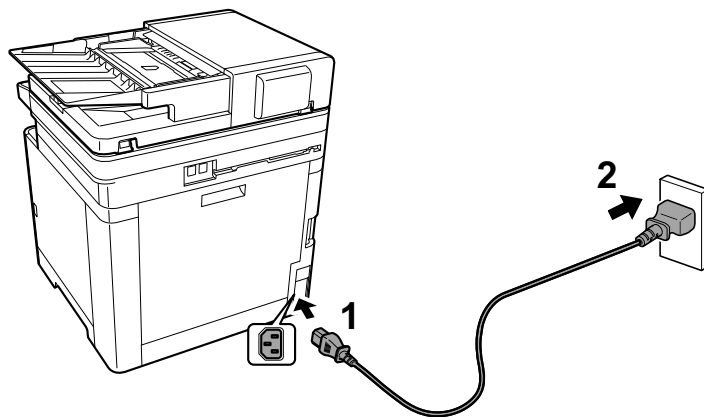

# G Replace Operation Panel Sheet

①

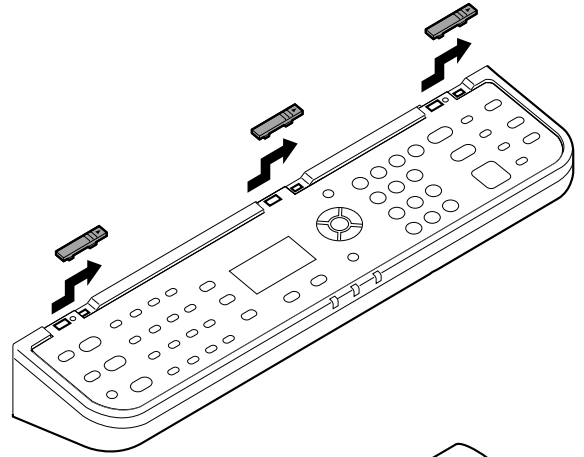
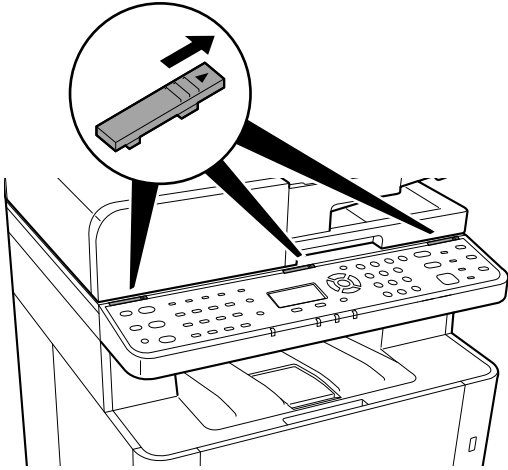

②

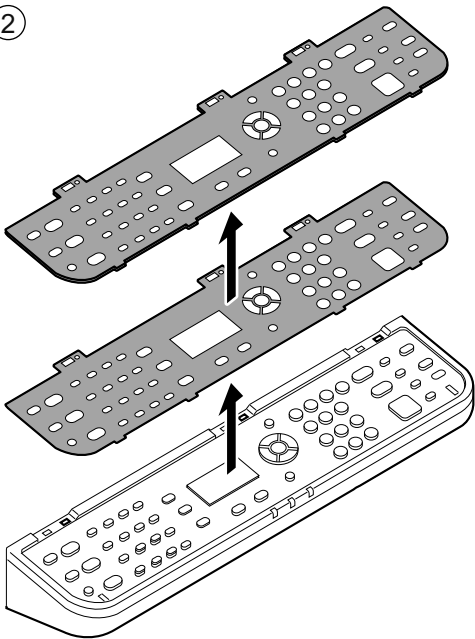

③

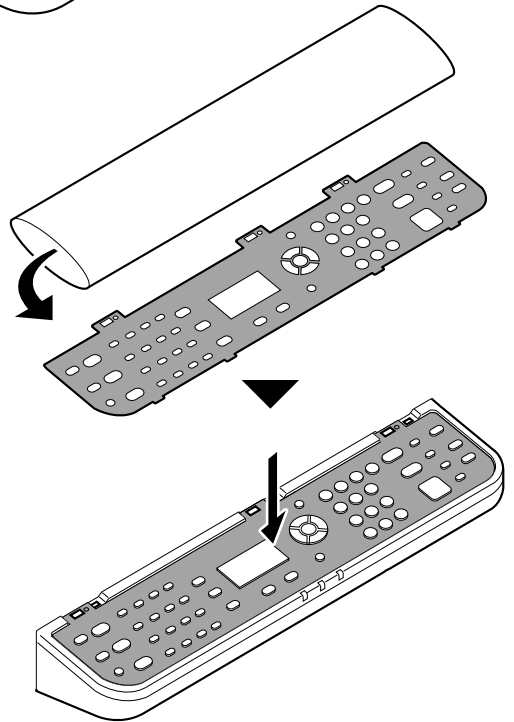

④

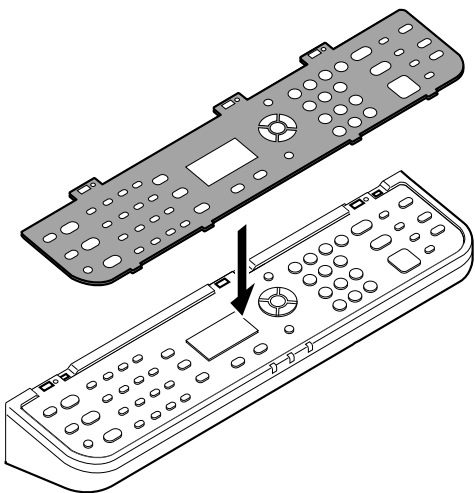

⑤

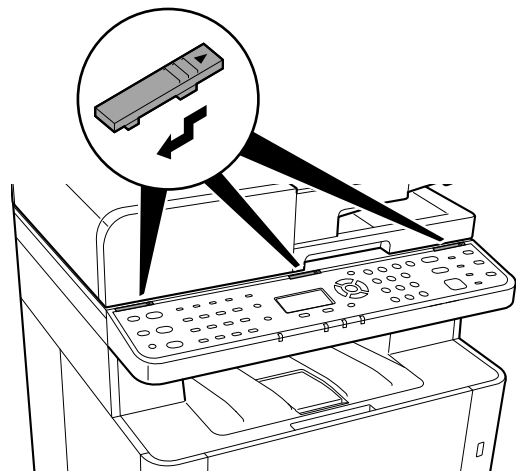

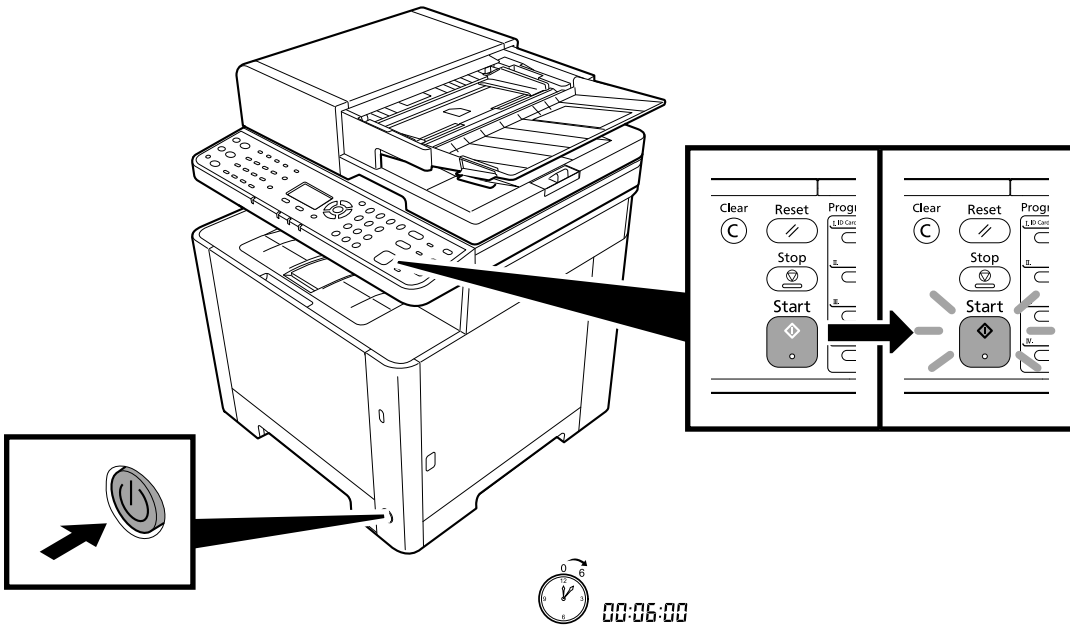



# Altitude Adjustment (1000m or higher Only)

1

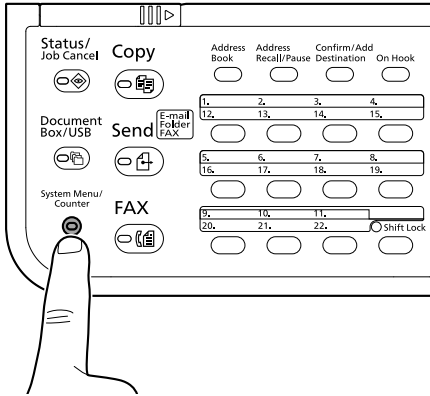

2

EN

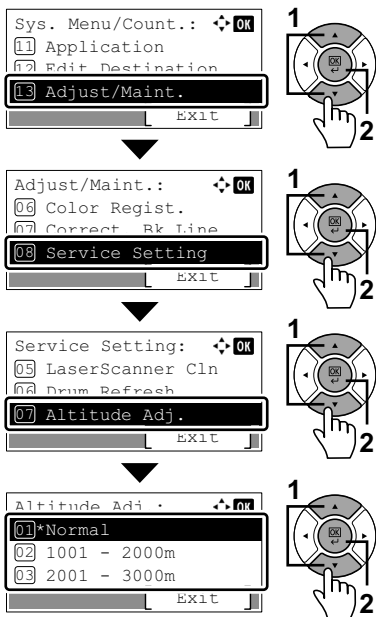

ES

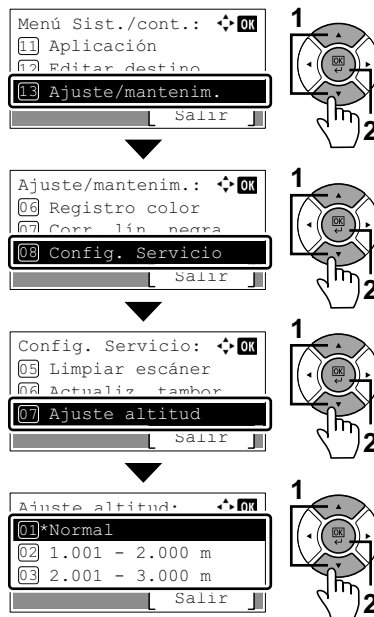

FR

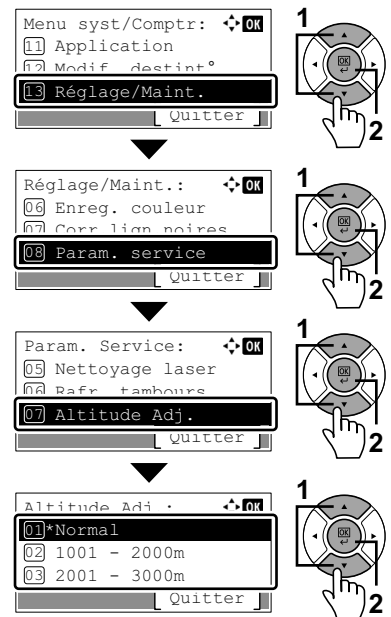

PT-BR

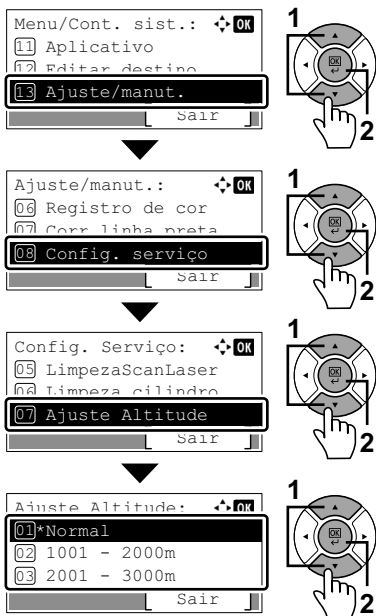

1

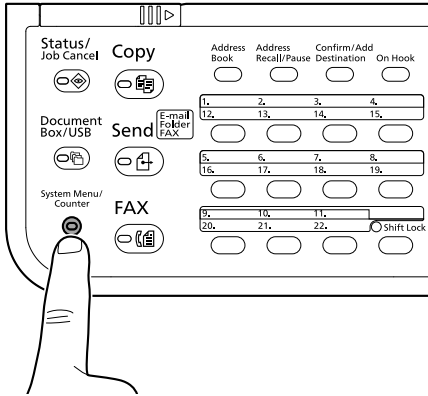

2

EN

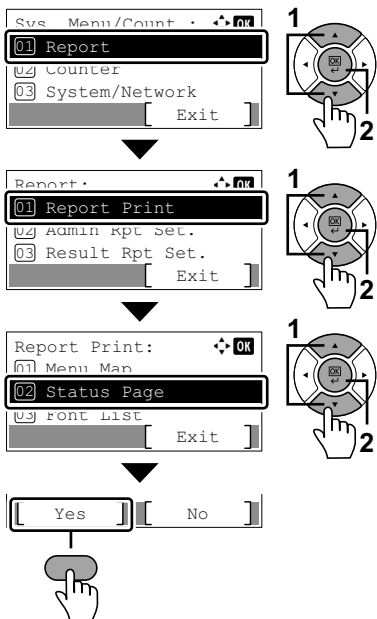

CA

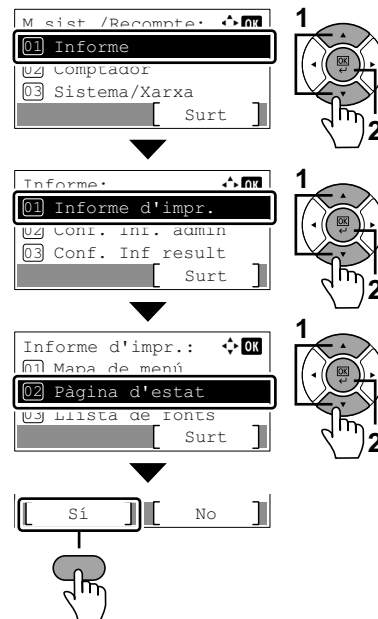

CS

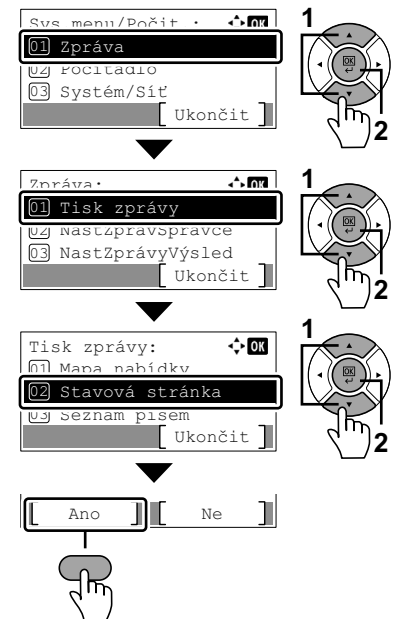

DA

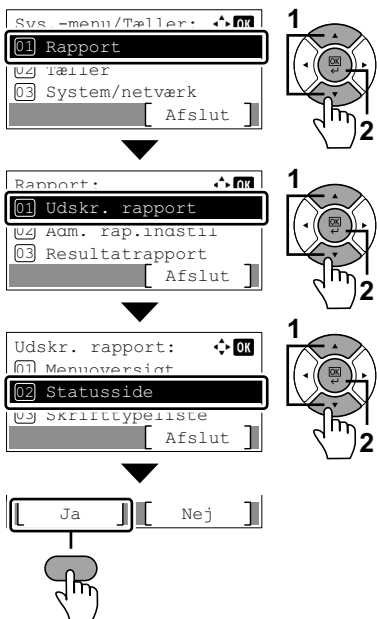

DE

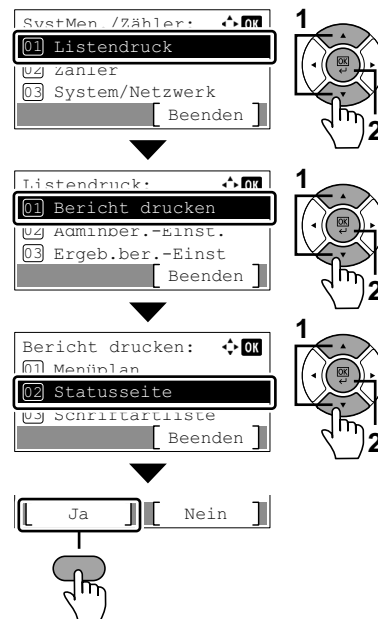

EL

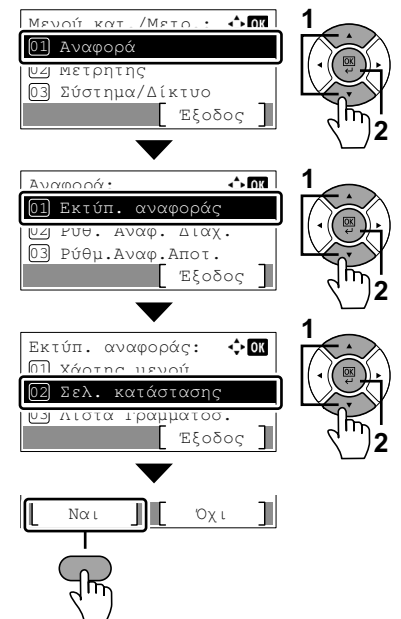

**ES**

Menú Sist /cont :

01 Informe

04 Contador

03 Sistema/red

Salir

1

2

Informe:

01 Impres. informe

04 Conf infOR admin

03 Conf inf result.

Salir

1

2

Impres. informe:

01 Diagrama menú

02 Páquina de estado

03 Lista de fuentes

Salir

1

2

Sí No

**FI**

Järvi val/määrä :

01 Raportti

04 Laskuri

03 Järj./Verkko

Poistu

1

2

Raportti:

01 Raportin tul.

04 valv.rap. as.

03 Tulosrap. As.

Poistu

1

2

Raportin tul.:

01 Valikkokartta

02 Tilasivu

03 fonttiuutteio

Poistu

1

2

Kyllä Ei

**FR**

Menu syst/Comptr:

01 Rapport

04 Compteur

03 Système/réseau

Quitter

1

2

Rapport:

01 Imprimer rapport

04 Param.rapp.admin

03 Param.rapp.résul

Quitter

1

2

Imprimer rapport:

01 Plan menu

02 Page d'état

03 Liste polices

Quitter

1

2

Oui Non

**HU**

Rend menü/száml:

01 Jelentés

04 Számiaio

03 Rendszer/Hálózat

Kilépés

1

2

Jelentés:

01 Jelentés nyomt.

04 Adm. jel. beall.

03 Visszaig. jel.

Kilépés

1

2

Jelentés nyomt.:

01 Menü tárkén

02 Állapotoldal

03 Fontkeszletek

Kilépés

1

2

Igen Nem

**IT**

Cont/menu sist:

01 Rapporto

04 Contatore

03 Sistema/Rete

Esci

1

2

Rapporto:

01 Stampa rapporto

04 Imp. rapp Admin.

03 Imp. rapp. Risul

Esci

1

2

Stampa rapporto:

01 Menu menu

02 Pagina stato

03 Bienco caratteri

Esci

1

2

Sì No

**NL**

Svs menu/Teller:

01 Rapport

04 Teller

03 System/Network

Einde

1

2

Rapport:

01 Druk rapport af

04 Inst.been.rapport

03 Inst.result.rapp

Einde

1

2

Druk rapport af:

01 Menu overzicht

02 Statuspagina

03 Lettertypes

Einde

1

2

Ja Nee

**NO**

Svs meny/teller:

01 Rapport

04 Teller

03 System/nettverk

Ut

1

2

Rapport:

01 Rapportutskrift

04 Rapport:kontroll

03 Resultatrapport

Ut

1

2

Rapportutskrift:

01 Menuoversikt

02 Status

03 Skriftliste

Ut

1

2

Ja Nei

**PL**

Menu svs /licz:

01 Raport

04 Licznik

03 System/Sieć

Wyjście

1

2

Raport:

01 Raportuj druk.

04 ust. rap. admin.

03 Ustaw. rap. wyn.

Wyjście

1

2

Raportuj druk.:

01 Menu menu

02 Strona stanu

03 Lista czcionek

Wyjście

1

2

Tak Nie

**PT-BR**

Menu/Cont sist:

01 Relatório

04 Contador

03 Sistema/Rede

Sair

1

2

Relatório:

01 Impr. relatório

04 Config relat adm

03 Aj. relat result

Sair

1

2

Impr. relatório:

01 Menu de menus

02 Página de status

03 Lista de fontes

Sair

1

2

Sim Não

PT-PT

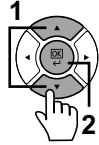
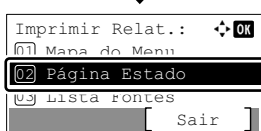
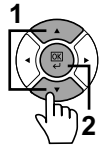
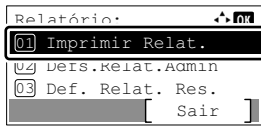
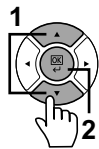
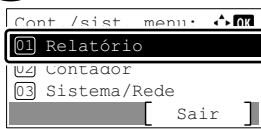

RO

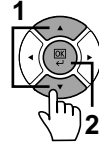
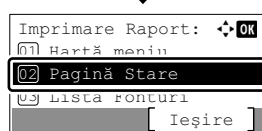
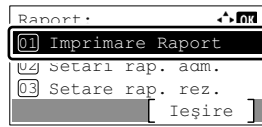
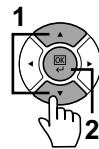
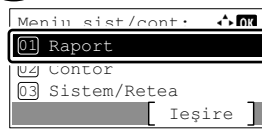

RU

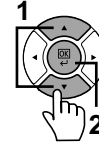
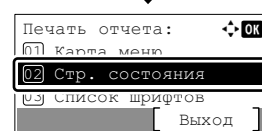
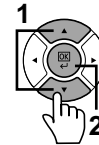
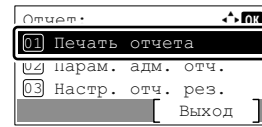
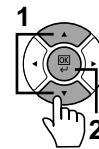
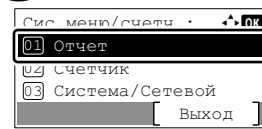

SV

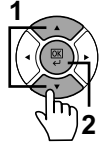
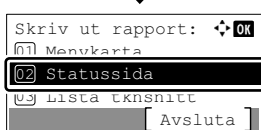
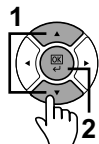
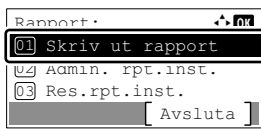
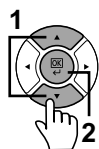
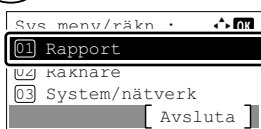

TR

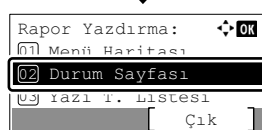
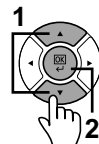
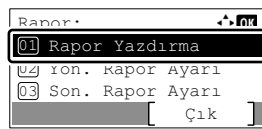
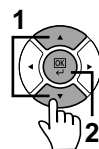
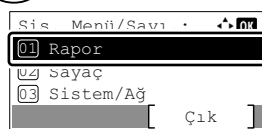

AR

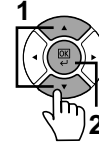
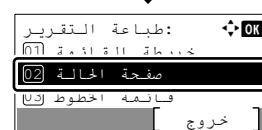
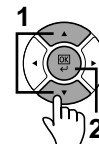
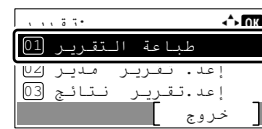
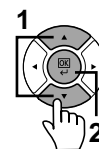
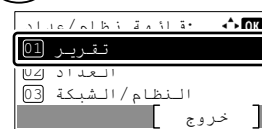

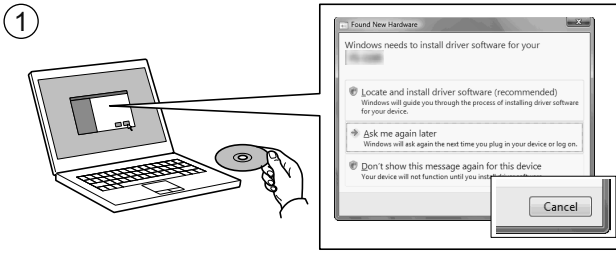

- ①
- ① If Found new Hardware window appears, click Cancel.
- ② Si es mostra la finestra "Found new Hardware" (S'ha detectat maquinari nou), feu clic a Cancel·la.
- ③ Pokud se zobrazí dialogové okno Nalezen nový hardware, klepněte na tlačítko Storno.
- ④ Vælg Annuller, hvis dialogboksen Der er fundet ny hardware.
- ⑤ Bitte legen Sie die beiliegende CD ein und folgen Sie den Anweisungen am Bildschirm, falls auf dem Bildschirm die Anzeige 'Neue Hardware gefunden' von Windows erscheint, drücken Sie Abbrechen.
- ⑥ Αν εμφανιστεί το παράθυρο Εύρεση νέου υλικού, κάντε κλικ στο κουμπί Άκυρο.
- ⑦ Si aparece la ventana Nuevo hardware encontrado, haga clic en Cancelar.
- ⑧ Jos näkyviin tulee Uusi laite löydetty -ikkuna, napsauta Peruuta.
- ⑨ Si la fenêtre Nouveau matériel détecté s'affiche, cliquez sur Annuler.
- ⑩ Ha az Új hardver telepítési ablak megjelenik, kattintson a Mégse gombra.
- ⑪ Se compare la finestra Trovato nuovo hardware, fare clic su Annulla.
- ⑫ Als het dialoogvenster nieuwe hardware gevonden verschijnt, selecteert u Annuleren.
- ⑬ Hvis vinduet Ny maskinvare funnet vises, klikk på Avbryt.
- ⑭ Jeśli wyświetlone zostanie okno Znaleziono nowy sprzęt, należy kliknąć przycisk Anuluj.
- ⑮ Se a janela Um novo Hardware foi encontrado aparecer, clique em Cancelar.
- ⑯ Se a janela Encontrar Novo Hardware aparecer, clique em Cancelar.
- ⑰ Dacă apare fereastra Found New Hardware, faceți clic pe Cancel.
- ⑱ Если появляется окно Найдено новое аппаратное обеспечение, щелкните Отменить.
- ⑲ Om Dialogfönstret visar 'Hittade ny hårdvara' klicka då på Avbryt.
- ⑳ Yeni Donanım Bulundu penceresi görüntülenirse, İptal'i tıklatin.
- ㉑ إذا ظهرت نافذة تم العثور على جهاز جديد ، انقر على إلغاء.

2

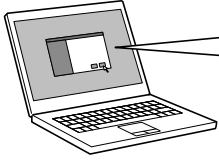

- EN** Follow the instructions in the installation wizard.
- CA** Seguiu les instruccions de l'auxiliar d'instal·lació.
- CS** Řiďte se pokyny v průvodci instalací.
- DA** Følg instruktionerne i installationsguiden.
- DE** Folgen Sie den Anweisungen des Schnelleinstellung Assistenten.
- EL** Ακολουθήστε τις οδηγίες στον οδηγό εγκατάστασης.
- ES** Siga las instrucciones del asistente de instalación.
- FI** Noudata asennusohjelman ohjeita.
- FR** Suivre les instructions de l'assistant d'installation.
- HU** Kövesse a telepítő varázsló utasításait.
- IT** Attenersi alle istruzioni della procedura guidata di installazione.
- NL** Volg de instructies in de installatiewizard.
- NO** Følg instruksjonene i installasjonsveiledningen.
- PL** Postępuj zgodnie z instrukcjami wyświetlanymi w oknie kreatora instalacji.
- PT-BR** Siga as instruções no assistente de instalação.
- PT-PT** Siga as instruções no assistente de instalação.
- RO** Urmați instrucțiunile expertului de instalare.
- RU** Следуйте инструкциям в окне мастера установки.
- SV** Följ anvisningarna i installationsguiden.
- TR** Kurulum sihirbazındaki talimatları izleyiniz.
- AR** اتبع تعليمات معالج التثبيت.

(EN) Login User Name: 2100  
Login Password: 2100

(NL) Aanmeld.gebr.nm: 2100  
Aanmeld.wachtw.: 2100

(CA) Nom inici sessió: 2100  
Contrasenya: 2100

(NO) Pålogg.brukernvn: 2100  
Passord: 2100

(CS) Přihl.uživ.jméno: 2100  
Přihl. Heslo: 2100

(PL) Nazwa logowania: 2100  
Hasło logowania: 2100

(DA) Login brugernavn: 2100  
Login adg.kode: 2100

(PT-BR) Usuário login: 2100  
Senha de login: 2100

(DE) Login-Name: 2100  
Login-Password: 2100

(PT-PT) N.Util.Iníc.Ses.: 2100  
P.pass.Iníc.Ses.: 2100

(EL) Σύνδ./Οv. Χρήστη: 2100  
Κωδ.Πρόσβ.Σύνδ.: 2100

(RO) Nume utilizator: 2100  
Parolă Conectare: 2100

(ES) Nom. us. in. ses: 2100  
Contr. in. ses.: 2100

(RU) Имя польз. д/вх.: 2100  
Пароль при входе: 2100

(FI) Kirj. Käytt.nimi: 2100  
Kirj. salasana: 2100

(SV) Användarnamn: 2100  
Inloggn.lösenord: 2100

(FR) Login nom utilis: 2100  
Login mot passe: 2100

(TR) O. Açma Kul. Adı: 2100  
O. Açma Parolası: 2100

(HU) Bej. Felh. név: 2100  
Bej. jelszó: 2100

(AR)

اسم الدخول : 2100  
كلمة مرور الدخول : 2100

(IT) Nome uten. login: 2100  
Password login: 2100

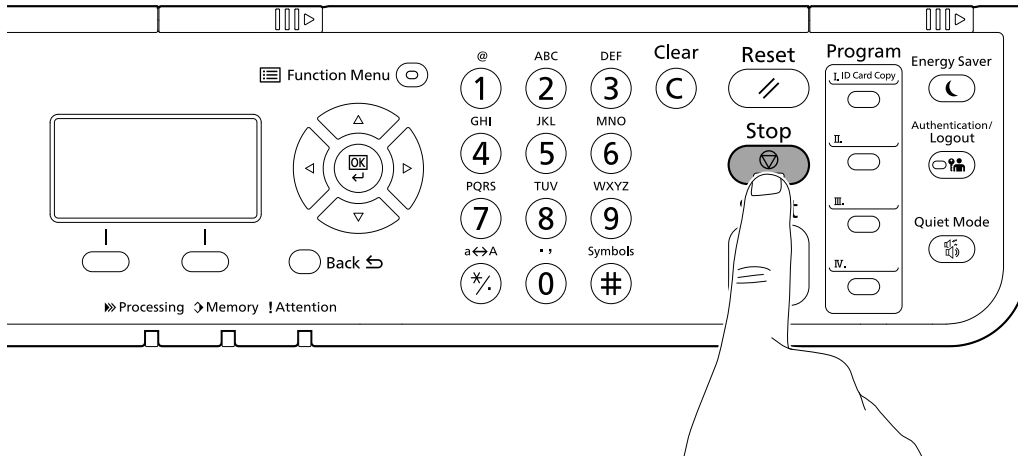

①

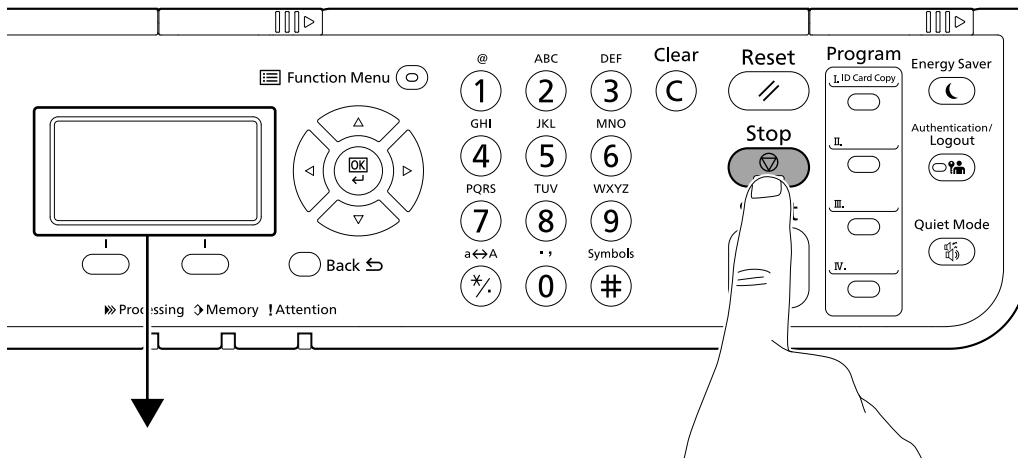

②

EN

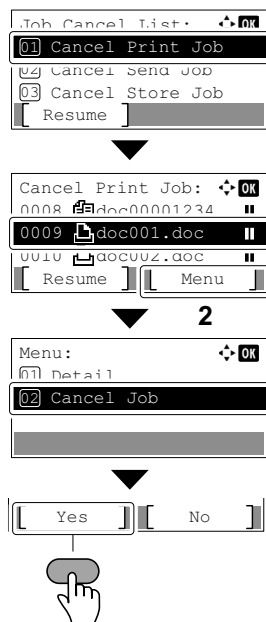

CA

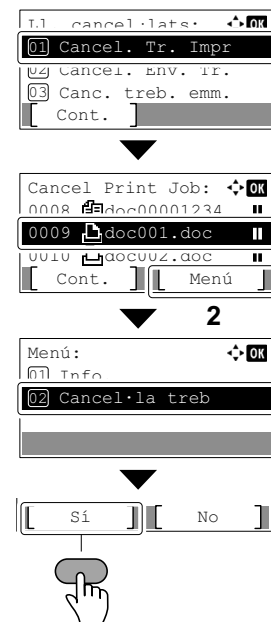

CS

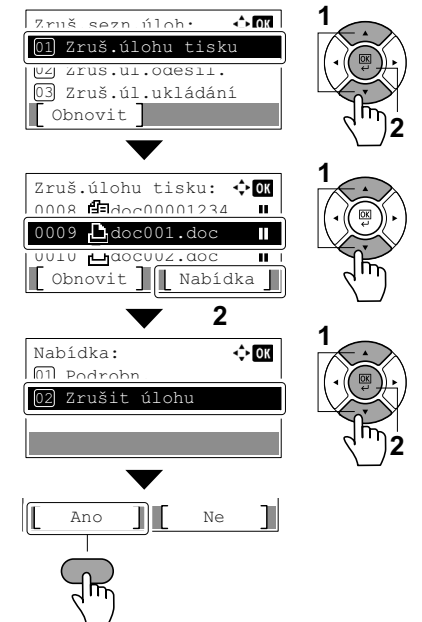



DA

Afbrudte jobs: 
01 Slet udskriftjob
02 Slet sende job
03 Slet gem job
Fortsæt

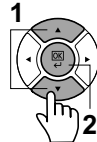

Slet udskriftjob: 
0008 doc00001234
0009 doc001.doc
0010 doc0002.doc
Fortsæt Menu

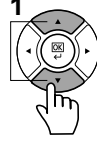

Menu: 
01 Detalie
02 Afbryd job

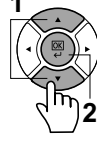

Ja Nej



DE

Job-Abbruchliste: 
01 Druckjob löschen
02 Sendejob löschen
03 Speich.job löscht
Weiter

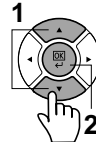

Druckjob löschen: 
0008 doc00001234
0009 doc001.doc
0010 doc0002.doc
Weiter Menu

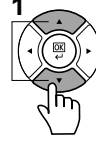

Menü: 
01 Detail
02 Auftragsabbruch

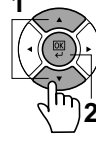

Ja Nein



EL

Ακύρω. λίστας εργ.: 
01 Ακύρ. Εργ. Εκτ.
02 Ακύρ. Εργ. Αποθ.
03 Ακύρ. Εργ. Αποθ.
Συνέχ.

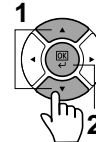

Ακύρ. Εργ. Εκτ.: 
0008 doc00001234
0009 doc001.doc
0010 doc0002.doc
Συνέχ. Menu



Μενού: 
01 Λεπτομέρ.
02 Ακύρωση εργασία

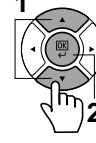

Ναι Όχι



ES

Lista cancel. tr.: 
01 Canc. trb. impr.
02 Canc. trb. envio
03 Canc. trb. alm.
Reanudar

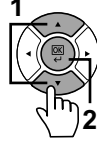

Canc. trb. impr.: 
0008 doc00001234
0009 doc001.doc
0010 doc0002.doc
Reanudar Menu

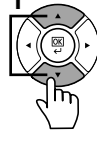

Menú: 
01 Detalle
02 Cancel. trabajo

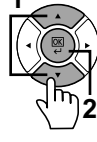

Sí No



FI

Tuõ peruttu lis.: 
01 Peru tulostus
02 Peru lanetys
03 Peru tallennus
Jatka

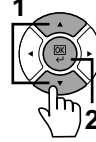

Peru tulostus: 
0008 doc00001234
0009 doc001.doc
0010 doc0002.doc
Jatka Valikko

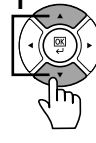

Valikko: 
01 Lisätiedot
02 Tyõn peruutus



Kyllä Ei



FR

Liste trav annul.: 
01 Annuler impr.
02 Annuler envoi
03 Annuler stockage
Reprise

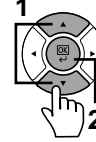

Annuler impr.: 
0008 doc00001234
0009 doc001.doc
0010 doc0002.doc
Reprise Menu

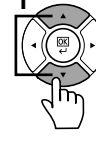

Menu: 
01 Détails
02 Annul. travaux

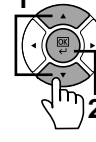

Oui Non



HU

Fldt visszav. l.: 
01 Nyomt. megszakít
02 Rûlges megszakít
03 Tárol. megszakít
Folytat

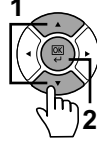

Nyomt. megszakít: 
0008 doc00001234
0009 doc001.doc
0010 doc0002.doc
Folytat Menu

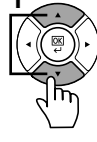

Menü: 
01 Részletek
02 Feladat visszav.

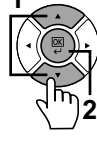

Igen Nem



IT

lista annul Job: 
01 Annulla stampa
02 Annulla invio
03 Annulla memoriz.
Ripresa

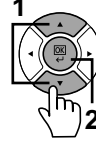

Annulla stampa: 
0008 doc00001234
0009 doc001.doc
0010 doc0002.doc
Ripresa Menu

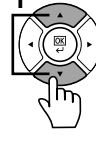

Menu: 
01 Dettagli
02 Annulla lavoro



Sì No



NL

Liist ann Taken: 
01 Afdr.taak annul.
02 Verz.taak annul.
03 Opsl.taak annul.
Hervat

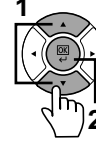

Afdr.taak annul.: 
0008 doc00001234
0009 doc001.doc
0010 doc0002.doc
Hervat Menu

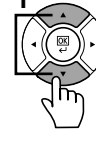

Menu: 
01 Details
02 Taak annuleren

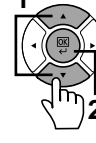

Ja Nee



NO

Jobbavbruddliste: OK

01 Avbryt utsk.jobb

02 Avbryt senjobb

03 Avbryt lagrejobb

Gjenop. ]

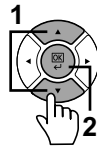

Avbryt utsk.jobb: OK

0008 doc00001234

0009 doc001.doc

0010 docvuuz.doc

Gjenop. ] Meny ]

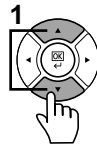

Meny: OK

01 Detalier

02 Jobbavbrudd

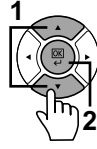

Ja ] Nei ]



PL

Lista anul zadań: OK

01 Anul. zad. druk.

02 Anul. zad. wys.

03 Anul. zad. zap.

Wznów ]

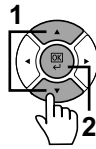

Anul. zad. druk.: OK

0008 doc00001234

0009 doc001.doc

0010 docvuuz.doc

Wznów ] Menu ]



Menu: OK

01 Szczegóły

02 Anulowanie zad.

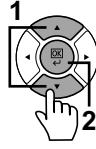

Tak ] Nie ]



PT-BR

Is. canc. trab.: OK

01 Canc. trab. imp.

02 Canc. trab. env.

03 Canc. trab. arm.

Retomar ]

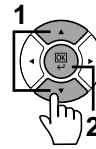

Canc. trab. imp.: OK

0008 doc00001234

0009 doc001.doc

0010 docvuuz.doc

Retomar ] Menu ]

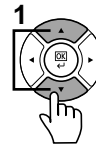

Menu: OK

01 Detalhe

02 Cancelar trab.

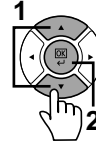

Sim ] Não ]



PT-PT

Lista Canc Trabs: OK

01 Canc. Tra. Impr.

02 Canc. Envio Tra.

03 Canc. Arm. Trab.

Contin. ]

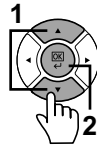

Canc. Tra. Impr.: OK

0008 doc00001234

0009 doc001.doc

0010 docvuuz.doc

Contin. ] Menu ]

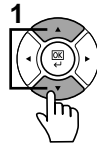

Menu: OK

01 Detalhe

02 Canc. Trabalho

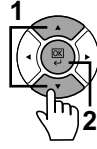

Sim ] Não ]



RO

Ist. anul lucr.: OK

01 Anulare printare

02 Anulare transm.

03 Anulare stocare

Reluare ]

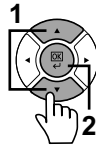

Anulare printare: OK

0008 doc00001234

0009 doc001.doc

0010 docvuuz.doc

Reluare ] Meniu ]



Meniu: OK

01 Detalii

02 Anulare Lucrare

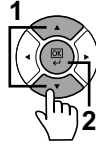

Da ] Nu ]



RU

Список отм. зал.: OK

01 Отменить печать

02 Отмена отправки

03 Отмена хранения

Продол. ]

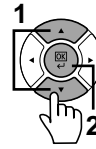

Отменить печать: OK

0008 doc00001234

0009 doc001.doc

0010 docvuuz.doc

Продол. ] Меню ]

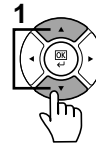

Меню: OK

01 Сведения

02 Отмена задания



Да ] Нет ]



SV

Lista avbr. jobb: OK

01 Avbryt utskrift

02 Avbr skicka jobb

03 Avbr lagra jobb

Uppta ]

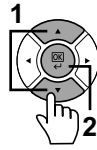

Avbryt utskrift: OK

0008 doc00001234

0009 doc001.doc

0010 docvuuz.doc

Uppta ] Meny ]

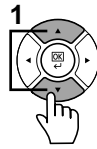

Meny: OK

01 Uppgift

02 Jobb avbrutet

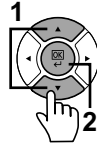

Ja ] Nej ]



TR

İş İptal Listesi: OK

01 Baskı işi iptal

02 Gönder. işi iptal

03 Saklanan iş iptal

Devam ]

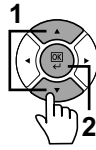

Baskı işi iptal: OK

0008 doc00001234

0009 doc001.doc

0010 docvuuz.doc

Devam ] Menü ]



Menü: OK

01 Avrıntı

02 İş İptal

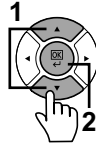

Evet ] Hayır ]



AR

قائمة إلغاء مهمة: OK

01 إلغاء مهمة طباعة

02 إلغاء مهمة إرسال

03 إلغاء مهمة تخزين

استئناف ]

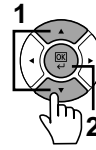

إلغاء مهمة طباعة: OK

0008 doc00001234

0009 doc.001doc

0010 doc.vuuzdoc

قائمة ] قائمة ]

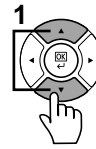

القائمة: OK

01 التفاصيل

02 إلغاء المهمة

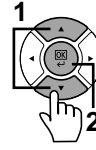

نعم ] لا ]



1

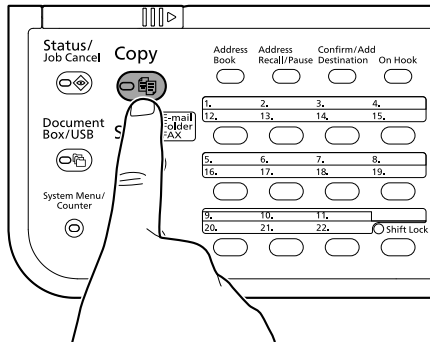

2

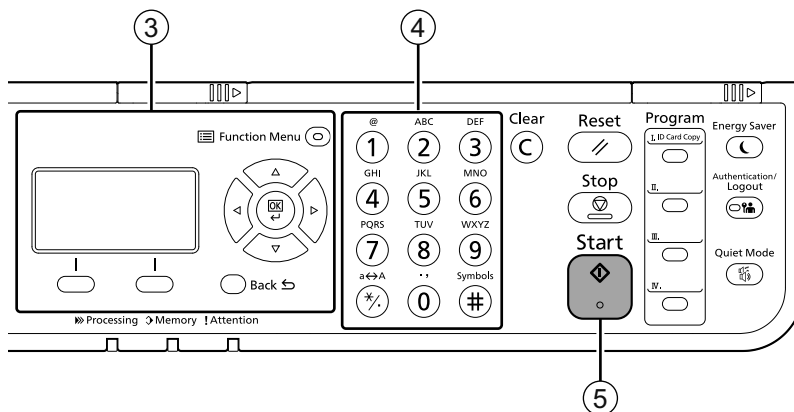
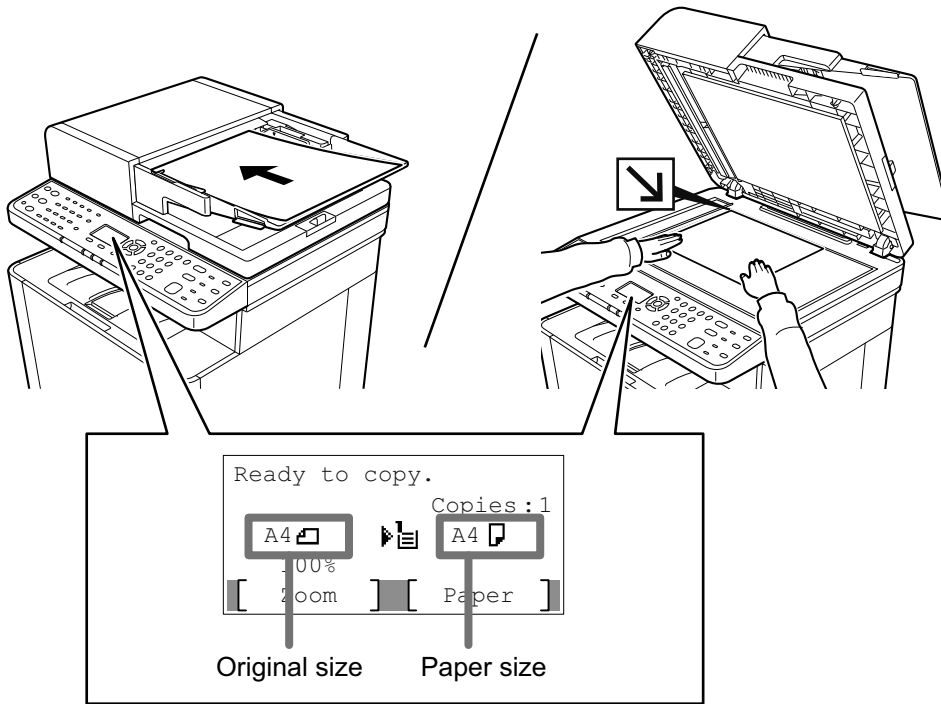

## Setup

EN

- 1 Launch your Web browser.
- 2 In the Address or Location bar, enter the machine's IP address or Printer Host Name.

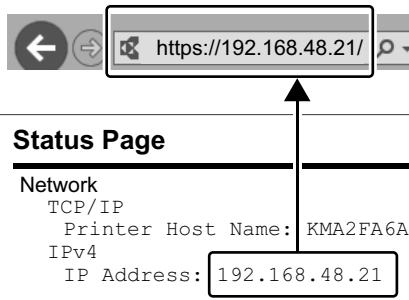

- 3 Enter the following and log in to Command Center RX with administrator authority.

Admin Login	User Name	Admin
	Password	Admin
	Login	

- 4 From the [Function Settings] menu, click [E-mail].
- 5 Set SMTP Protocol [On], and then enter the following items.
  - SMTP Server Name
  - E-mail Size Limit
  - Sender Address

CA

- 1 Inicieu el navegador web.
- 2 A la barra d'adreesos o d'ubicació, introduïu l'adreça IP del dispositiu o el nom de l'amfitrió de la impressora.

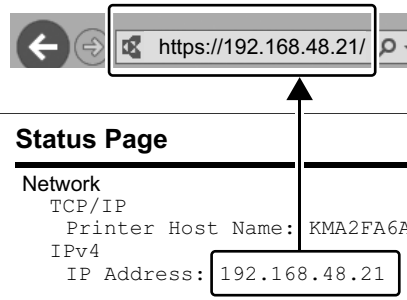

- 3 Introduïu les dades següents i inicieu la sessió a Command Center RX amb privilegis d'administrador.

Inicia sessió com a administrador	Nom d'usuari	Admin
	Contrasenya	Admin
	Inicia sessió	

- 4 Al menú [Configuració de funcions], feu clic a [E-mail].
- 5 Establiu el Protocol SMTP en [Activat] i introduïu les dades següents.
  - Nom del servidor SMTP
  - Limit de mida de l'E-mail
  - Adreça del remitent

CS

- 1 Spust'te váš webový prohlížeč.
- 2 V záložce Adresa nebo Umístění zadejte IP adresu zařízení nebo jméno hostitelské tiskárny.

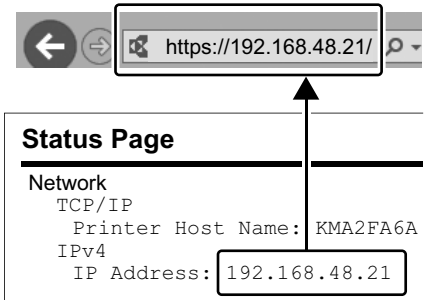

- 3 Zadejte níže uvedené informace a přihlaste se do Command Center RX s administrátorským oprávněním.

Přihlášení správce	Uživatelské jméno	Admin
	Heslo	Admin
	Přihlášení	

- 4 V nabídce [Nastavení funkcí] klikněte na [E-mail].
- 5 Nastavte protokol SMTP na [Zapnuto], a poté zadejte následující položky.
  - Název serveru SMTP
  - Limit velikosti e-mailu
  - Adresa odesílatele

DA

- 1 Start din webbrower.
- 2 Indtast maskinens IP-adresse eller printerens værtnavn i adresse- eller placeringslinjen.

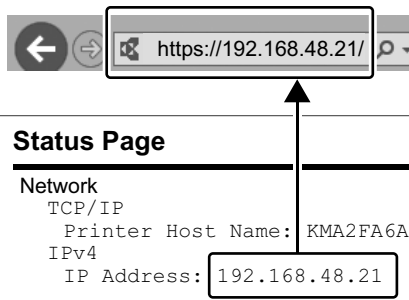

- 3 Indtast følgende og log ind i Command Center RX med administratorrettigheder.

Administratorlogon	Brugernavn	Admin
	Adgangskode	Admin
	Log på	

- 4 I menuen [Funktionsindstillinger], klik på [E-mail].
- 5 Indstil SMTP-protokol til [Til], og indtast derpå følgende enheder.
  - SMTP-servernavn
  - Størrelsesbegrænsning på e-mails
  - Afsenderadresse

DE

- 1 Starten Sie Ihren Webbrowser.
- 2 In der Adresszeile geben Sie die IP-Adresse des Geräts oder den Hostnamen wie eine Internetadresse (URL) ein.

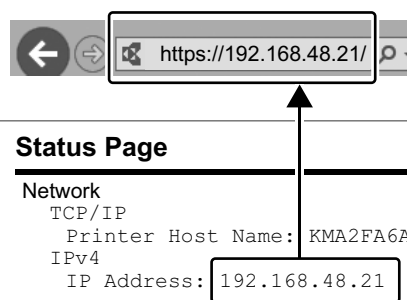

- 3 Geben Sie Folgendes ein und melden sich am Command Center RX mit Administrator-Rechten an.

Admin Anmeldung	Anwendername	Admin
	Passwort	Admin
	Anmelden	

- 4 Im Menü [Funktions-Einstellungen] klicken Sie auf [E-Mail].
- 5 Stellen Sie das SMTP-Protokoll auf [Ein] und geben Sie die folgenden Punkte ein.
  - SMTP-Servername
  - E-Mail-Größenlimit
  - Absenderadresse

EL

- 1 Εκκινήστε το πρόγραμμα περιήγησής σας στο Internet.
- 2 Στο πλαίσιο Διεύθυνση ή Τοποθεσία, εισάγετε τη διεύθυνση IP του μηχανήματος ή το όνομα του κεντρικού εκτυπωτή.

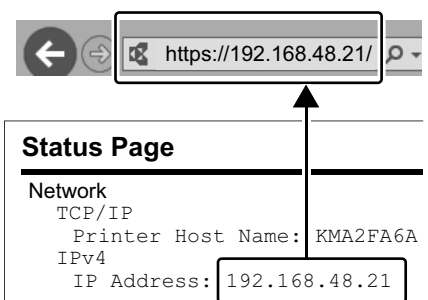

- 3 Εισάγετε τα ακόλουθα και συνδεθείτε στο Command Center RX με δικαιώματα διαχειριστή.

Σύνδεση Διαχειριστή	Όνομα χρήστη	Admin
	Κωδικός πρόσβασης	Admin
	Σύνδεση	

- 4 Από το μενού [Ρυθμίσεις Λειτουργιών], κάντε κλικ στο [E-mail].
- 5 Ρυθμίστε το Πρωτόκολλο SMTP σε [Ενεργοποίηση], και έπειτα εισάγετε τα ακόλουθα στοιχεία.
  - Όνομα διακομιστή SMTP
  - Όριο μεγέθους e-mail
  - Διεύθυνση αποστολέα

ES

- 1 Inicie el explorador de Internet.
- 2 En la barra de direcciones o de ubicación, introduzca la dirección IP de la máquina o el nombre de host de la impresora.

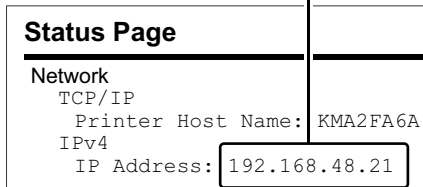

- 3 Introduzca lo siguiente e inicie sesión en Command Center RX con autoridad de administrador.

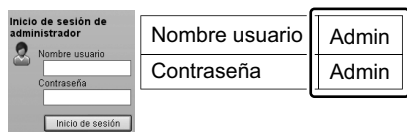

- 4 En el menú [Configuración de función], haga clic en [E-mail].

- 5 Configure Protocolo SMTP como [Activado] y después introduzca los valores de los siguientes elementos.

- Nombre de servidor SMTP
- Tam. lím. e-m.
- Dirección del remitente

FI

- 1 Käynnistä verkkoselaimesi.
- 2 Kirjoita IP-osoite osoiteriville tai sijaintipalkkiin tietokoneen tai tulostinpalvelimen isäntänimi.

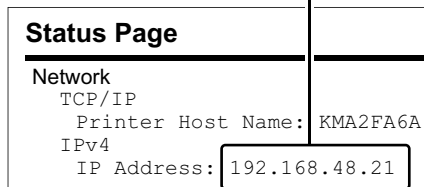

- 3 Syötä seuraava, ja kirjaudu Command Center RX:ään ylläpitäjän tunnuksilla.

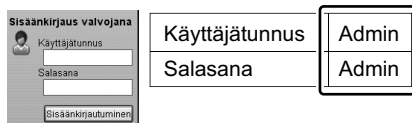

- 4 Klikkaa [Sähköposti] [Toimintoasetus] -valikosta.

- 5 Aseta SMTP-protokolla [Käytössä] -asentoon ja syötä seuraavat tiedot.

- SMTP-palvelimen nimi
- Sähköpostin kokorajoitus
- Lähettäjän osoite

FR

- 1 Lancer le navigateur Internet.
- 2 Dans la barre d'adresses ou d'emplacement, saisir l'adresse IP de la machine ou le nom d'hôte de l'imprimante.

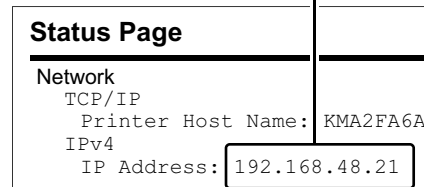

- 3 Saisir les informations suivantes et se connecter à Command Center RX avec des droits d'administrateur.

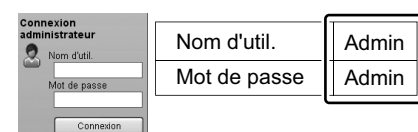

- 4 Dans le menu [Paramètres de fonction], cliquer sur [E-mail].

- 5 Régler le protocole SMTP sur [Activé], puis saisir les informations suivantes.

- Nom de serveur SMTP
- Lim. taille e-mail
- Adresse de l'expéditeur

HU

- 1 Indítsa el a webböngészőjét.
- 2 A címsorba vagy a hely sávjába írja be a készülék IP címét vagy a nyomtató állomásnevét.

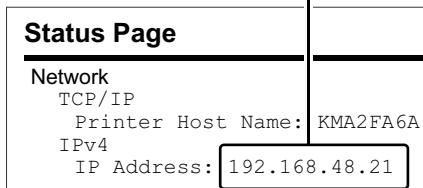

- 3 Írja be az alábbiakat, és rendszergazdai jogosultságokkal jelentkezzen be a Command Center RX alkalmazásba.

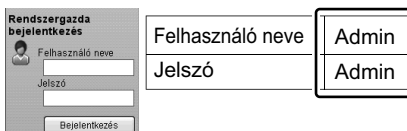

- 4 A [Funkcióbeállítások] menüben kattintson az [E-mail] lehetőségre.

- 5 Az SMTP protokoll opciót kapcsolja [Be], és adja meg az alábbi tételeket.

- SMTP-szerver neve
- E-mail méretkorlátozása
- Feladó címe

IT

- 1 Avviare il browser web.
- 2 Nella barra degli indirizzi, immettere l'indirizzo IP della macchina oppure il Nome host della stampante.

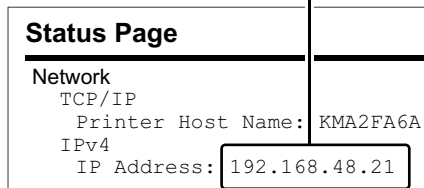

- 3 Immettere le seguenti voci e accedere a Command Center RX con privilegi di amministratore.

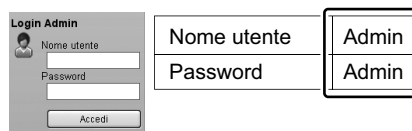

- 4 Nel menu [Impostazioni di funzione], fare clic su [Posta elettronica].

- 5 Impostare Protocollo SMTP su [On], quindi immettere le seguenti voci.

- Nome server SMTP
- Limite dim. email
- Indirizzo mittente

NL

- 1 Start uw webbrowser.
- 2 In de adres-of locatiebalk, voer het IP-adres van het apparaat of printer hostnaam in.

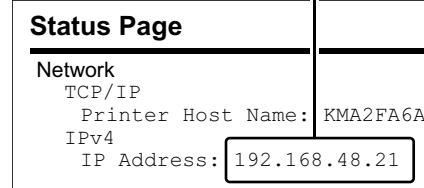

- 3 Voer het volgende in en meld u aan bij Command Center RX met beheerdersrechten.



- 4 In het menu [Functie-instellingen], klik op [E-mail].

- 5 Stel SMTP-protocol in op [Aan] en voer vervolgens de volgende items in.

- SMTP-servernaam
- Groottebeperking e-mail
- Adres afzender

NO

- 1 Åpne webleseren din.
- 2 Legg inn maskinens IP-adresse eller skriverens vertsnavn i adresselinjen.

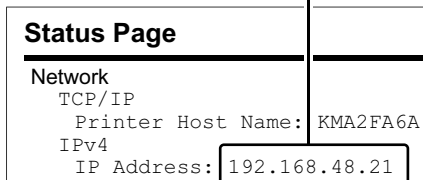

- 3 Tast inn følgende og logg deg på Command Center RX med administratorrettigheter.

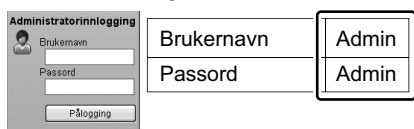

- 4 Fra menyen [Funksjoninnstillinger], klikk på [E-post].
- 5 Sett SMTP-protokoll [På], og tast deretter inn følgende elementer.
  - SMTP-servernavn
  - Størrelsesgrense for e-post
  - Avsenderadresse

PL

- 1 Uručom przeglądarkę internetową.
- 2 W polu na pasku adresu lub lokalizacji wprowadź adres IP urządzenia lub nazwę hosta drukarki.

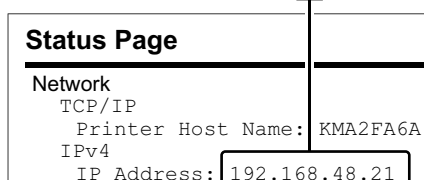
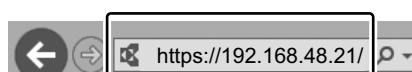

- 3 Wprowadź następujące poświadczenia, aby zalogować się do narzędzia Command Center RX na konto z uprawnieniami administratora.

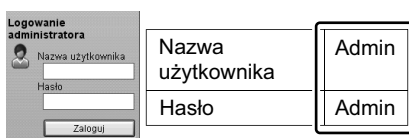

- 4 Z menu [Ustawienia funkcji] wybierz polecenie [E-mail].
- 5 Dla ustawienia Protokół SMTP wybierz wartość [Wi.], a następnie wprowadź wartości następujących ustawień.
  - Nazwa serwera SMTP
  - Limit rozmiaru e-mail
  - Adres nadawcy

PT-BR

- 1 Inicie o seu navegador web.
- 2 Na barra Endereço ou Local, insira o endereço de IP da máquina ou o nome do host da impressora.

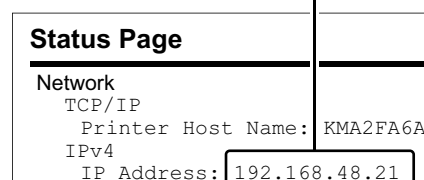
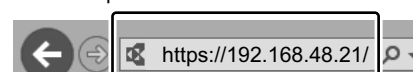

- 3 Insira o seguinte e faça o login no Command Center RX com autoridade de administrador.

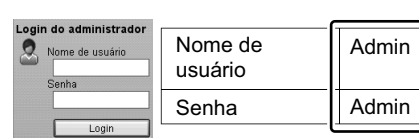

- 4 No menu [Configurações da função], clique em [E-mail].
- 5 Defina o Protocolo SMTP como [Ativado] e depois insira os seguintes itens.
  - Nome do servidor de SMTP
  - Lim.tam. p/e-mail
  - Endereço do remetente

PT-PT

- 1 Abra o seu browser.
- 2 Na barra de endereço ou localização insira o endereço IP da máquina ou Nome de Anfitrião da Impressora.

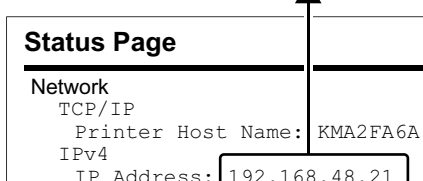
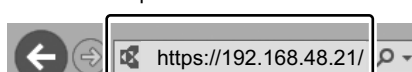

- 3 Insira o seguinte e inicie sessão no Command Center RX com permissão de administrador.

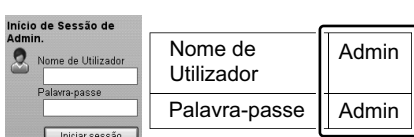

- 4 A partir do menu [Definições da função], clique em [E-mail].
- 5 Defina o Protocolo SMTP para [Ligado] e insira os seguintes itens.
  - Nome do Servidor SMTP
  - Limite de Tamanho de E-mail
  - Endereço do Destinatário

RO

- 1 Lansați browserul dvs. de internet.
- 2 În bara de adresă sau poziție, introduceți adresa IP a aparatului sau numele de gazdă al imprimantei.

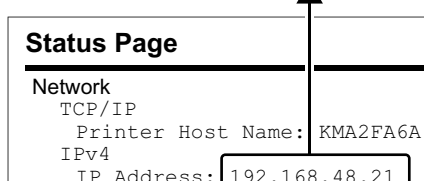
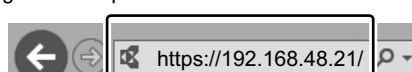

- 3 Introduceți următoarele și conectați-vă la Command Center RX cu autoritate de administrator.

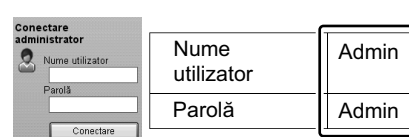

- 4 Din meniul [Setări funcționale], faceți clic pe [E-mail].
- 5 Setări Setări Protocol SMTP pe [Pornit], și apoi introduceți următoarele elemente.
  - Nume server SMTP
  - Limită dimensiune e-mail
  - Adresă expeditor

RU

- 1 Запустите веб-обозреватель.
- 2 В строке «Адрес» или «Местоположение» введите IP-адрес аппарата или имя хоста принтера.

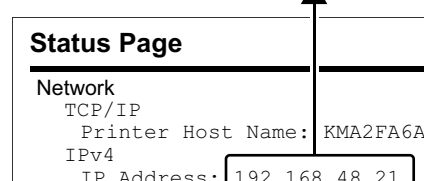
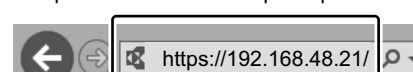

- 3 Введите следующие данные и выполните вход в систему Command Center RX с правами администратора.



- 4 В меню [Настройки функций] выберите [Электронная почта].
- 5 Для протокола SMTP Установите [Вкл.], а затем введите следующие данные.
  - Имя сервера SMTP
  - Предел размера сообщения эл. почты
  - Адрес отправителя

SV

- 1 Starta din webbläsare.
- 2 Skriv in maskinens IP-adress eller skrivarens värddamn i adressfältet.

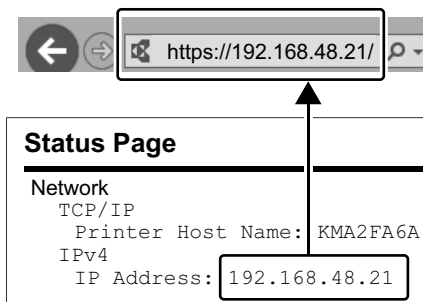

- 3 Skriv in följande och logga in i Command Center RX som administratör.

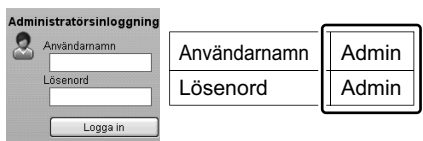

- 4 Från menyn [Funktionsinställningar], klicka på [E-post].
- 5 Aktivera SMTP-protokoll [På], och skriv sedan in följande uppgifter.
  - SMTP-servernamn
  - Storleksbegränsning för e-postmeddelanden
  - Avsändaradress

TR

- 1 Web tarayıcınızı açın.
- 2 Adres veya Yer çubuğuna, makinenin IP adresini yazın.

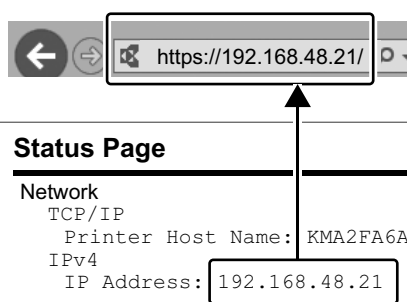

- 3 Aşağıdakileri girin veya yönetici yetkisiyle Command Center RX'de oturum açın.

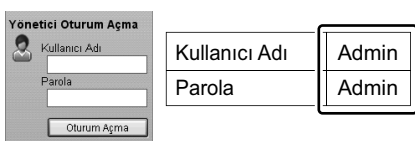

- 4 [Fonksiyon Ayarları] menüsünden, [E-posta] üzerine tıklayın.
- 5 SMTB protokolü ayarını [Açık] konumuna getirin ve sonra aşağıdaki öğeleri yazın.
  - SMTP Sunucu Adı
  - E-posta Boyutu Sınırı
  - Gönderen Adresi

AR

- 1 افتح مستعرض الإنترنت الخاص بك.
- 2 في شريط الموقع أو العنوان، أدخل عنوان IP الخاص بالجهاز أو اسم مضيف الطباعة.

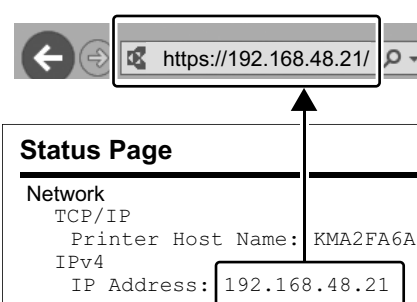

- 3 أدخل ما يلي وسجل للدخول في Command Center RX بامتيازات المدير المسؤول.

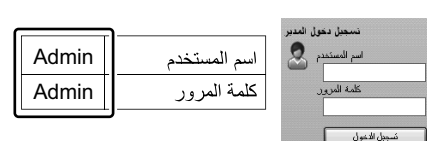

- 4 من القائمة [إعدادات الوظائف]، انقر فوق [البريد الإلكتروني].
- 5 اضبط بروتوكول SMTP على وضع [تشغيل]، ثم أدخل العناصر التالية.
  - اسم ملقم SMTP
  - حدود حجم البريد الإلكتروني
  - عنوان المرسل

# Send

①

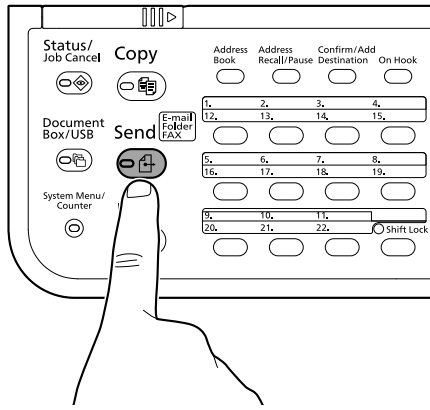

②

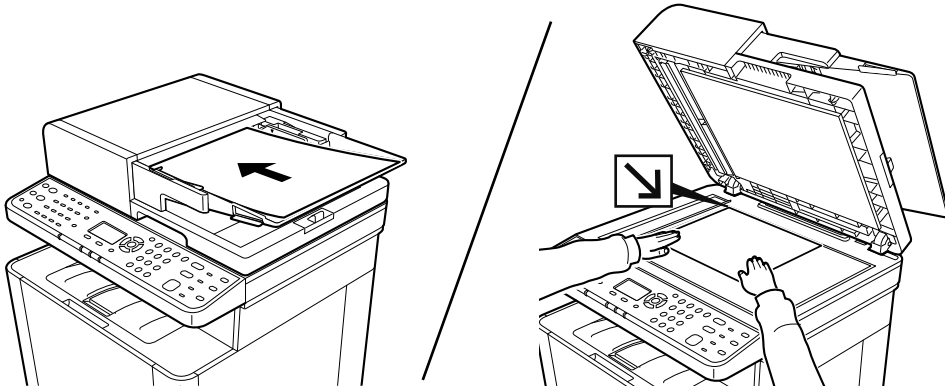

③

EN

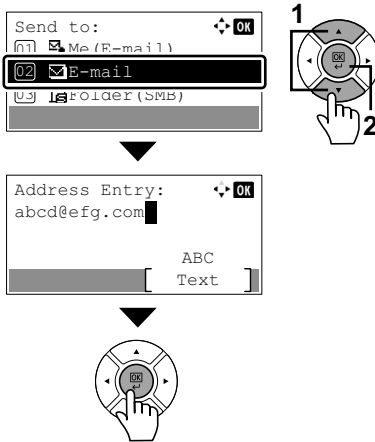

CA

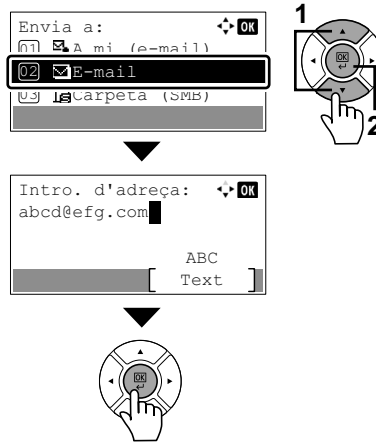

CS

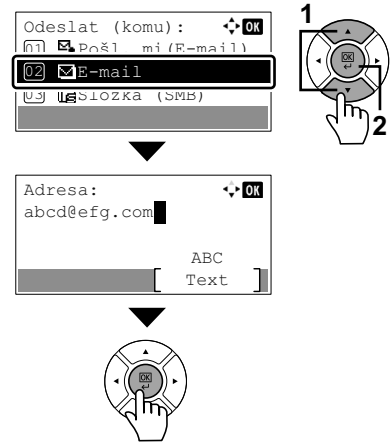

DA

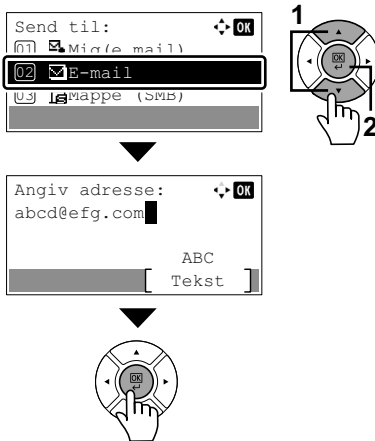

DE

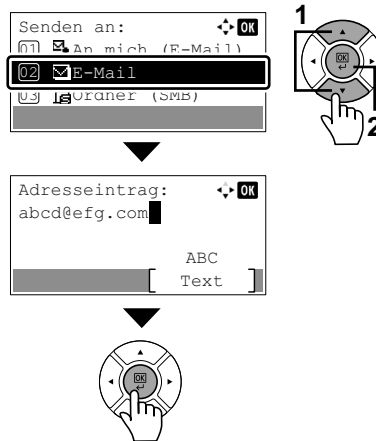

EL

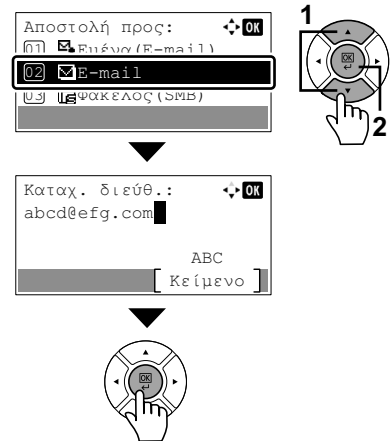



ES

Enviar a: OK

01 Yo (E-mail)

02 E-mail

03 Carpeta (SMB)

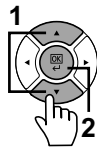

Entr. Direc: OK

abcd@efg.com

ABC

Texto



FI

Lähetä: OK

01 Minulle (sähkö)

02 Sähköposti

03 Kansio (SMB)

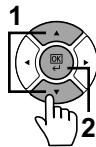

Osoitt syöttö: OK

abcd@efg.com

ABC

Teksti



FR

Envoyer vers: OK

01 Person (E-mail)

02 E-mail

03 Dossier (SMB)

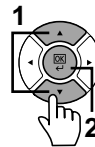

Entrée adresse: OK

abcd@efg.com

ABC

Texte



HU

Címzett: OK

01 Macamnak (E-mail)

02 E-mail

03 mappa (SMB)

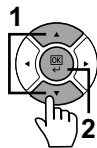

Címbejegyzés: OK

abcd@efg.com

ABC

Szöveg

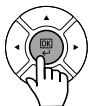

IT

Invia a: OK

01 A me (E-mail)

02 E-mail

03 cartella (SMB)

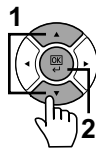

Indirizzo: OK

abcd@efg.com

ABC

Testo



NL

Verzenden naar: OK

01 Mi (E-mail)

02 E-mail

03 map (SMB)

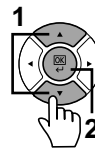

Adresinvoer: OK

abcd@efg.com

ABC

Tekst



NO

Send til: OK

01 Meg (E-post)

02 E-post

03 mappe (SMB)

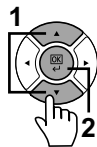

Adresse inng: OK

abcd@efg.com

ABC

Tekst



PL

Wyślij do: OK

01 Do mnie (e-mail)

02 E-mail

03 folder (SMB)

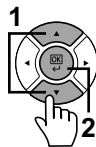

Wpis adresu: OK

abcd@efg.com

ABC

Tekst



PT-BR

Enviar para: OK

01 Eu (E-mail)

02 E-mail

03 pasta (SMB)

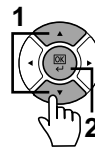

Adic. Entrada: OK

abcd@efg.com

ABC

Texto



PT-PT

Enviar para: OK

01 Meu (E-mail)

02 E-mail

03 pasta (SMB)

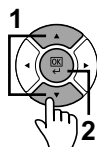

Entr. endereço: OK

abcd@efg.com

ABC

Texto



RO

Trimitere la: OK

01 Mie (E-mail)

02 E-mail

03 folder (SMB)



Introd. adresă: OK

abcd@efg.com

ABC

Text



RU

Передать: OK

01 Мне (эл почта)

02 E-mail

03 папка (SMB)

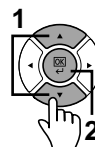

Поле адреса: OK

abcd@efg.com

ABC

Текст



SV

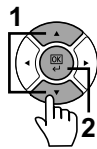

TR

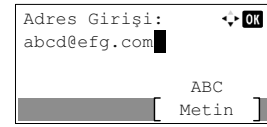
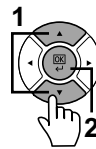
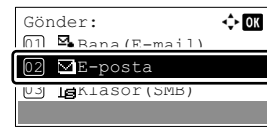

AR

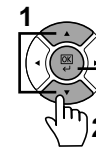
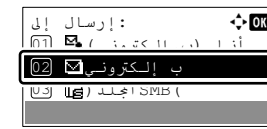

4

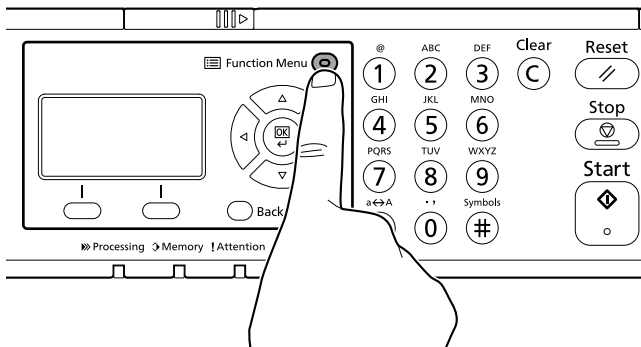

5

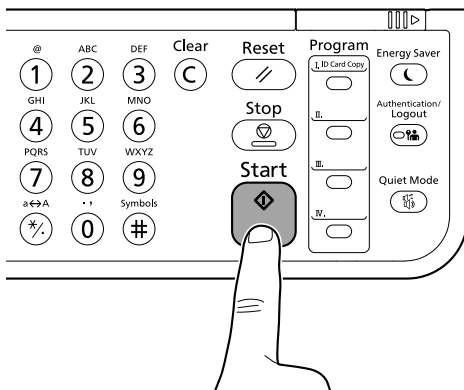

①

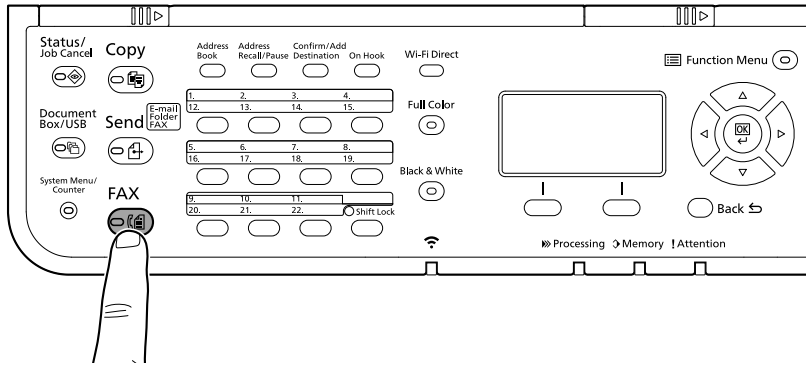

②

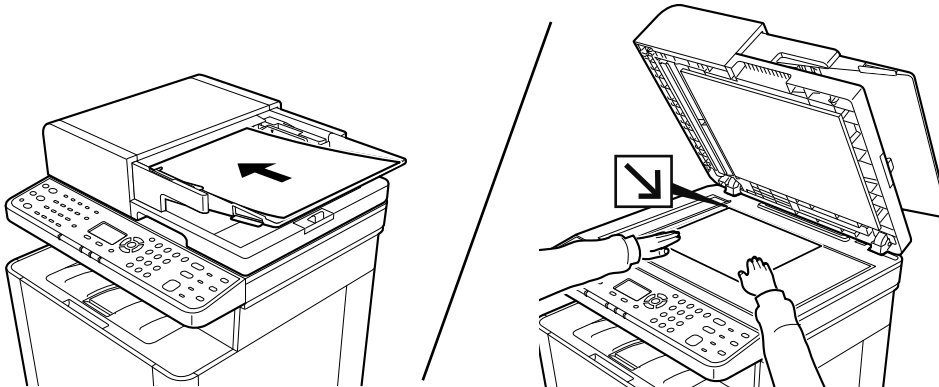

③

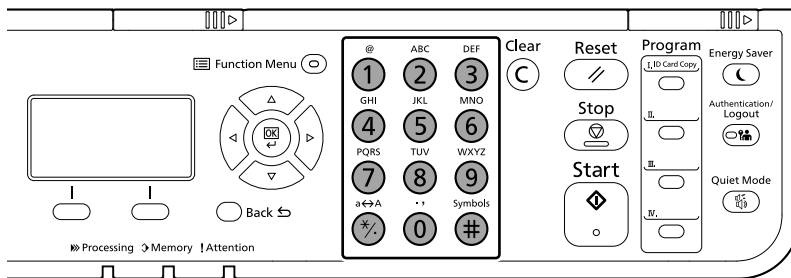

EN

FAX No. Entry: **OK**  
 0123456789 █  
 [ Chain ] [ Detail ]

CA

Intro. n° de FAX: **OK**  
 0123456789 █  
 [ Cadena ] [ Info. ]

CS

Zadání fax. čís.: **OK**  
 0123456789 █  
 [ Řetěz ] [ Podrobn. ]

DA

Angiv faxnr.: **OK**  
 0123456789 █  
 [ Kæde ] [ Detalje ]

DE

Faxnr. invoeren: **OK**  
 0123456789 █  
 [ Keten ] [ Details ]

EL

Εισαγ. Αριθ. ΦΑΞ: **OK**  
 0123456789 █  
 [ Αλυσίδα ] [ Λεπτομ. ]

ES

Ingreso nro. FAX: **OK**  
 0123456789 █  
 [ Cadena ] [ Detalle ]

FI

Kirjfaxsin nro: **OK**  
 0123456789 █  
 [ Ketju ] [ Tiedot ]

FR

Entrée N° de FAX: **OK**  
 0123456789 █  
 [ Chaînes ] [ Détails ]

HU

FAX szám megad.:

[ Lánç ] [ Részl. ]

IT

N. voce FAX:

[ Catena ] [ Dettagli ]

NL

Faxnr. invoeren:

[ Keten ] [ Details ]

NO

Faksnummer:

[ Kjede ] [ Detaljer ]

PL

Wpis nr FAKSU:

[ Łańcuch ] [ Szczegóły ]

PT-BR

Entrada n° FAX:

[ Cadeia ] [ Detalhe ]

PT-PT

Entrada N° FAX:

[ Cadeia ] [ Detalhe ]

RO

Introd. nr. FAX:

[ În Lanț ] [ Detaliu ]

RU

Ввод № факса:

[ Цепь ] [ Сведения ]

SV

Ange faxnummer:

[ Kedja ] [ Uppgift ]

TR

FAKS No Girişi:

[ Zincir ] [ Ayrıntı ]

AR

إدخال رقم الفاكس:

[ التسلسل ] [ التفاصيل ]

4

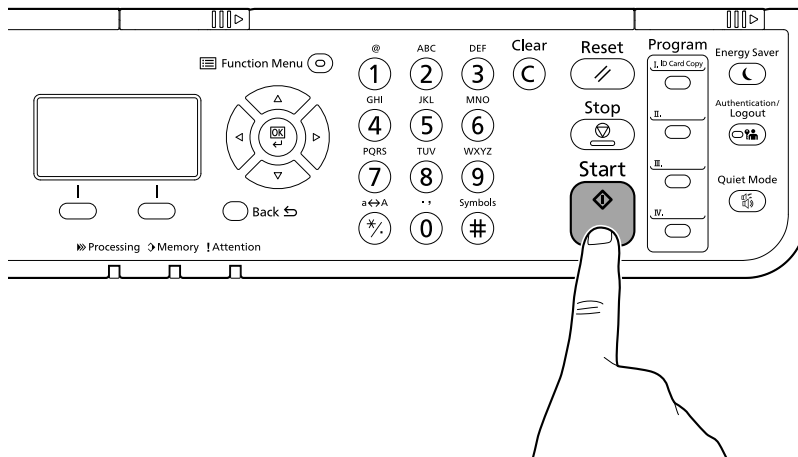

## From a PC

①

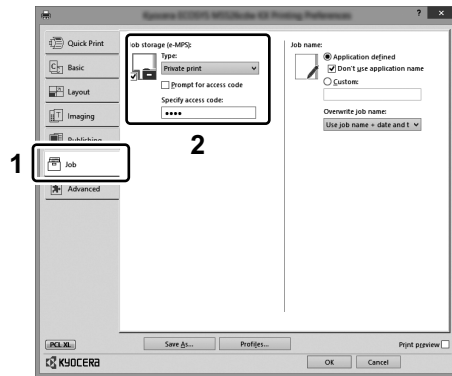

- ① EN To activate the private printing from the PC, set the items No. 1 and 2 in the screen.
- ① CA Per activar la impressió privada des d'un PC, configureu els elements núm. 1 i núm. 2 de la pantalla.
- ① CS Pro aktivaci soukromého tisku z počítače vyberte položku č.1 a 2 na obrazovce.
- ① DA For at aktivere privat udskrivning fra pc'en, indstilles enheder nr. 1 og 2 på skærmen.
- ① DE Um den privaten Druck vom PC aus zu aktivieren, stellen Sie die Punkte 1 und 2 am Bildschirm ein.
- ① EL Για να ενεργοποιήσετε την ιδιωτική εκτύπωση από τον υπολογιστή, ορίστε τα στοιχεία Αρ. 1 και 2 στην οθόνη.
- ① ES Para activar la impresión privada desde el PC, configure los elementos número 1 y 2 en la pantalla.
- ① FI Aktivoidaksesi yksityisen tulostuksen PC:ltä, aseta tiedot nro 1 ja 2 ruudulla.
- ① FR Pour activer l'impression privée à partir de l'ordinateur, définir les éléments 1 et 2 sur l'écran.
- ① HU A magán nyomtatás számítógépről történő aktiváláshoz a képernyőn állítsa be az 1. és a 2. tételt.
- ① IT Per attivare la stampa privata da PC, configurare le voci N. 1 e N. 2 sulla schermata.
- ① NL Om privé afdrucken vanaf de pc te activeren, stel de items nummer 1 en 2 op het scherm in.
- ① NO For å aktivere privat utskrift fra PC, sett element nr. 1 og 2 på skjermen.
- ① PL Aby aktywować drukowanie prywatne z poziomu komputera, skonfiguruj ustawienia oznaczone cyframi 1 i 2 na tym ekranie.
- ① PT-BR Para ativar a impressão privada no PC, defina os itens N. 1 e 2 na tela.
- ① PT-PT Para activar a impressão privada no PC, configure os itens n.º 1 e 2 no ecrã.
- ① RO Pentru a activa imprimarea privată de la PC, setați elementele 1 și 2 de pe ecran.
- ① RU Для активации конфиденциальной печати с ПК выполните настройку пунктов 1 и 2 на экране.
- ① SV För att aktivera funktionen privat utskrift från PC:n, ställ in uppgifterna nr 1 och 2 på skärmen.
- ① TR PC'den özel yazdırma işlemini aktive etmek için, ekranda madde No.1 ve 2'yi ayarlayın.
- ① AR لتشغيل الطباعة الشخصية من جهاز الكمبيوتر، عين العنصرين رقم 1 و2 في الشاشة.

# From the Operation Panel

1

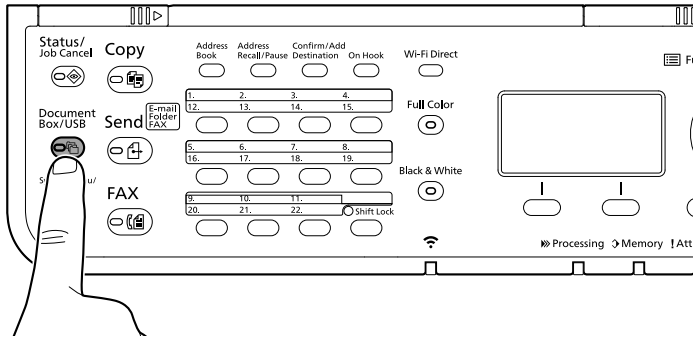

2

EN

Document Box:  OK

01 Sub Address Box  
02 Polling Box  
03 Job Box

Job Box:  OK

01 Private/Stored  
Quick/Proof

Private/Stored:  OK

User 01  
User 02  
User 03

User 01:  OK

Data 01   
Data 02   
Data 03   
Menu Select

User 01:  OK

01 Print  
Delete

Copies:  OK

(1 - 999 ---)  
--- copies

Yes No

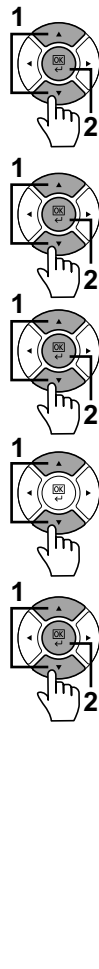

CA

Casella de docs.:  OK

01 Casella subadr.  
02 Casella Polling  
03 Casella treball

Casella treball:  OK

01 Privada/Desada  
Ràpida/Prova

Privada/Desada:  OK

User 01  
User 02  
User 03

User 01:  OK

Data 01   
Data 02   
Data 03   
Menú Selec.

User 01:  OK

01 Imprimeix  
Esborra

Còpies:  OK

(1 - 999)  
--- còpies

Si No

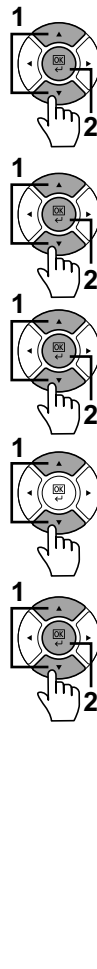

CS

Schr dokumentů:  OK

01 Pole Podadresy  
02 Schr. na dot.  
03 Schránka úlohy

Schránka úlohy:  OK

01 Soukromý/Uložený  
Rychlý/kontrolní

Soukromý/Uložený:  OK

User 01  
User 02  
User 03

User 01:  OK

Data 01   
Data 02   
Data 03   
Nabídka Vybrat

User 01:  OK

01 Tisk  
Odstranit

Počet kopií:  OK

(1 - 999 ---)  
--- kopie

Ano Ne

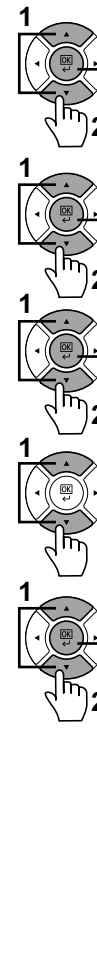

DA

Dokumentboks:  OK

01 Underadresseboks  
02 Pollingboks  
03 Jobboks

Jobboks:  OK

01 Privat/Gemt.  
Hurtig/gennemse

Privat/Gemt.:  OK

User 01  
User 02  
User 03

User 01:  OK

Data 01   
Data 02   
Data 03   
Menu Vælg

User 01:  OK

01 Udskriv  
Slet

Kopier:  OK

(1 - 999 ---)  
--- kopier

Ja Nej

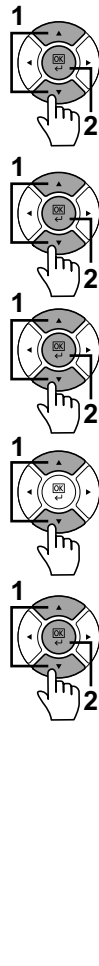

DE

Dokumentenbox:  OK

01 Eigene Faxbox  
02 Abrufbox  
03 Auftragsbox

Auftragsbox:  OK

01 Privat/Gespeich.  
Schnell/Prüfen

Privat/Gespeich.:  OK

User 01  
User 02  
User 03

User 01:  OK

Data 01   
Data 02   
Data 03   
Menü Wählen

User 01:  OK

01 Drucken  
Löschen

Kopien:  OK

(1 - 999 ---)  
--- Kopien

Ja Nein

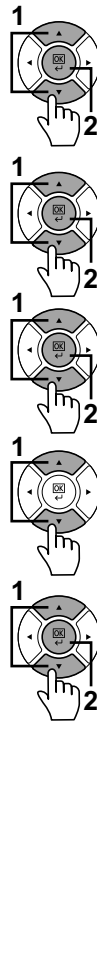

EL

Θυρίδα Εγγράφου:  OK

01 Πλαίσιο Υποδιεύ.  
02 Αιτίδα Διαλογής  
03 Θυρίδα εργασίας

Αιτίδα εργασίας:  OK

01 Ιδιωτ./Αποθήκευ.  
Γρήγορη/Ελεγχος

Ιδιωτ./Αποθήκευ.:  OK

User 01  
User 02  
User 03

User 01:  OK

Data 01   
Data 02   
Data 03   
Μενού Επιλογή

User 01:  OK

01 Εκτύπωση  
Διαγραφή

Αντίγραφο:  OK

(1 - 999 ---)  
--- αντίγ.

Ναι Όχι

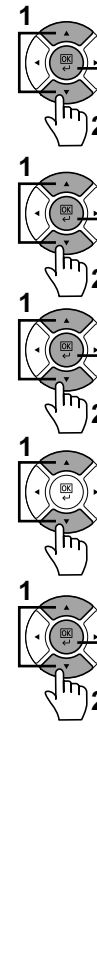

**ES**

Buzón doc.:  OK

01 Buzón subdirecc.  
02 Buzón sandeo  
03 Buzón trabajos

Buzón trabajos:  OK

01 Privado/almacen.  
Rápido/revisar

Privado/almacen.:  OK

User 01  
User 02  
User 03

User 01:  OK

Data 01   
Data 02   
Data 03   
Menú Seleccionar

User 01:  OK

01 Imprimir  
Eliminar

Copias:  OK

(1 - 999 ---)  
--- copias

Si No

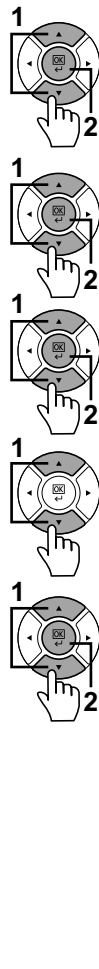

**FI**

Dokumenttilokero:  OK

01 Aliosoitelaat.  
02 Kucelulaatikko  
03 Työlaatikko

Työlaatikko:  OK

01 Yksit./tallenn.  
Rika/koevedos

Yksit./tallenn.:  OK

User 01  
User 02  
User 03

User 01:  OK

Data 01   
Data 02   
Data 03   
Valikko Valitse

User 01:  OK

01 Tulosta  
Poista

Kopiot:  OK

(1 - 999 ---)  
--- kopioi

Kyllä Ei

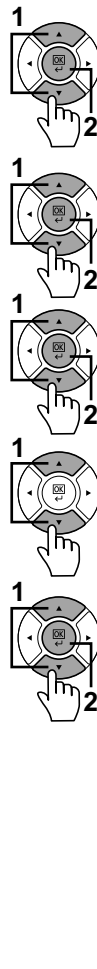

**FR**

Bte de documents:  OK

01 Boîte ss-adresse  
02 Boîte Balling  
03 Boîte travaux

Boîte travaux:  OK

01 Privé/Stocké  
Rapide/Preuve

Privé/Stocké:  OK

User 01  
User 02  
User 03

User 01:  OK

Data 01   
Data 02   
Data 03   
Menu Sélectionner

User 01:  OK

01 Imprimer  
Supprimer

Copies:  OK

(1 - 999 ---)  
--- copies

Oui Non

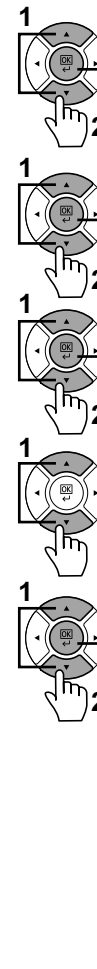

**HU**

Dokumentumfiók:  OK

01 Mellékazon. fiók  
02 Tárolt. fiók  
03 Feladat fiók

Feladat fiók:  OK

01 Privát/Tárolt  
Gyors/Próbá

Privát/Tárolt:  OK

User 01  
User 02  
User 03

User 01:  OK

Data 01   
Data 02   
Data 03   
Menü Kiválasztás

User 01:  OK

01 Nyomtatás  
Eltávolítás

Példányszám:  OK

(1 - 999 ---)  
--- péld.

Igen Nem

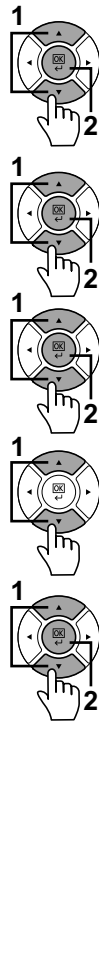

**IT**

Cas. Documenti:  OK

01 Box SubAddress  
02 Casella mailing  
03 Casella lavoro

Casella lavoro:  OK

01 Privata/Memoriz.  
Copia Vel/Contr.

Privata/Memoriz.:  OK

User 01  
User 02  
User 03

User 01:  OK

Data 01   
Data 02   
Data 03   
Menu Selez.

User 01:  OK

01 Stampa  
Elimina

Copie:  OK

(1 - 999 ---)  
--- copie

Sì No

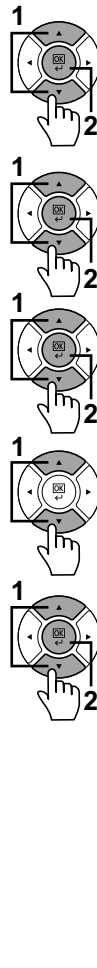

**NL**

Documentbox:  OK

01 Vak Subadres  
02 Balling box  
03 Taakvenster

Taakvenster:  OK

01 Privé/Opgesl.tk  
Snelk./Iesten

Privé/Opgesl.tk:  OK

User 01  
User 02  
User 03

User 01:  OK

Data 01   
Data 02   
Data 03   
Menu Kies

User 01:  OK

01 Afdrukken  
Verwijderen

Exemplaren:  OK

(1 - 999 ---)  
--- xemp.

Ja Nee

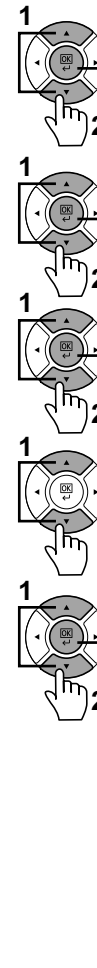



**NO**

Dokumentboks:  OK

01 Underadr. boks  
02 Ballingboks  
03 Boks

Boks:

01 Privat/Lagret  
Hurtig/rest

Privat/Lagret:  OK

User 01  
User 02  
User 03

User 01:

Data 01   
Data 02   
Data 03   
Meny Velg

User 01:

01 Skriv ut  
Sielt

Eksemplarer:

(1 - 999 ---)  
--- ksemp

Ja Nei

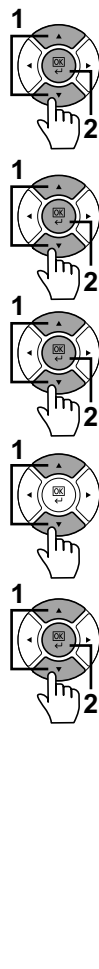

**PL**

Skrzynka dok.:  OK

01 Skrz. adr. pom.  
02 Skrz. adnut  
03 Okno zadań.

Okno zadań:

01 Prywatne/Zachow.  
Szybki/koboczy

Prywatne/Zachow.:  OK

User 01  
User 02  
User 03

User 01:

Data 01   
Data 02   
Data 03   
Menu Wybierz

User 01:

01 Drukuj  
usun

Kopie:

(1 - 999 ---)  
--- opie

Tak Nie

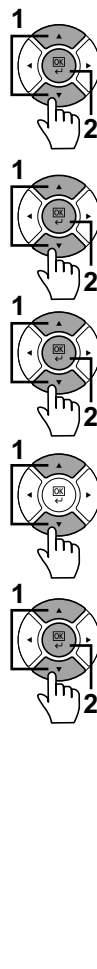

**PT-BR**

Caixa docs.:  OK

01 Caixa sub-ender.  
02 Caixa calata  
03 Caixa trabalho

Caixa trabalho:

01 Privado/Armaz.  
Rapida/prova

Privado/Armaz.:  OK

User 01  
User 02  
User 03

User 01:

Data 01   
Data 02   
Data 03   
Menu Selec.

User 01:

01 Imprimir  
EXCLUIR

Cópias:

(1 - 999 ---)  
--- ópias

Sim Não

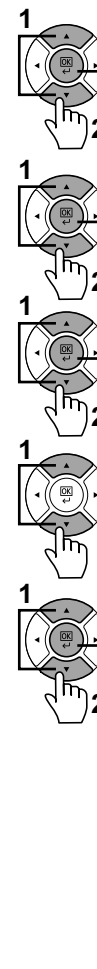

**PT-PT**

Caixa Doc.:  OK

01 Caixa de subend.  
02 Caixaalling  
03 Caixa de Trabs.

Caixa de Trabs:

01 Privada/Armaz.  
Rapida/prova

Privada/Armaz.:  OK

User 01  
User 02  
User 03

User 01:

Data 01   
Data 02   
Data 03   
Menu Selecc.

User 01:

01 Imprimir  
Eliminar

Cópias:

(1 - 999 ---)  
--- ópias

Sim Não

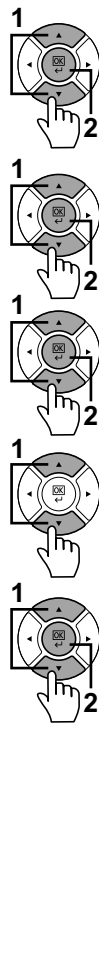

**RO**

Casetă Document:  OK

01 Casetă subadresă  
02 Casetă Interog  
03 Casetă lucrare

Casetă lucrare:

01 Privată/Stocată  
Rapida/probare

Privată/Stocată:  OK

User 01  
User 02  
User 03

User 01:

Data 01   
Data 02   
Data 03   
Menu Select.

User 01:

01 Imprimare  
ștergere

Copii:

(1 - 999 ---)  
--- opii

Da Nu

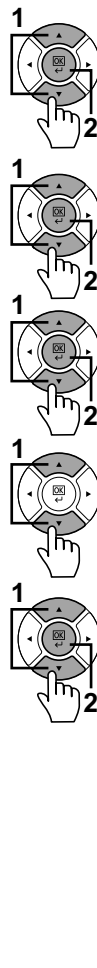

**RU**

Ящик докум.:  OK

01 Ящик доп. адреса  
02 Ящик отроса  
03 Поле заданий

Поле заданий:

01 Конфид./Сохран.  
выстр./проон.

Конфид./Сохран.:  OK

User 01  
User 02  
User 03

User 01:

Data 01   
Data 02   
Data 03   
Меню Выбрать

User 01:

01 Печать  
удалить

Копии:

(1 - 999 ---)  
--- копии

Да Нет

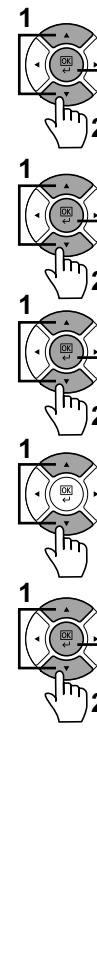

SV

Dokumentlâda:  OK  
01 Subadressbox  
02 Ballningelâda  
03 Jobblâda

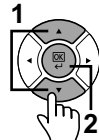

Jobblâda:  OK  
01 Privat/Sparad  
Sjabb/prool

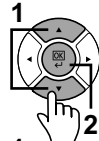

Privat/Sparad:  OK  
User 01  
User 02  
User 03

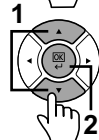

User 01:  OK  
Data 01   
Data 02   
Data 03   
Meny Vâlj

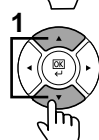

User 01:  OK  
01 Skriv ut  
Kaderâ

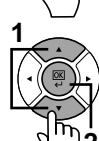

Kopior:  OK  
(1 - aqa ---)  
--- kopior

Ja Nej



TR

Belge Kutusu:  OK  
01 Alt Adres Kutusu  
02 Çağırma Kutusu  
03 İş Kutusu

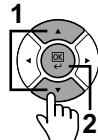

İş Kutusu:  OK  
01 Özel/Saklanan  
Hızlı/Düzeit

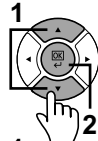

Özel/Saklanan:  OK  
User 01  
User 02  
User 03

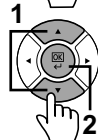

User 01:  OK  
Data 01   
Data 02   
Data 03   
Menü Seç

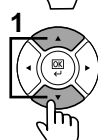

User 01:  OK  
01 Yazdır  
Sii

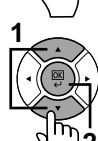

Kopyalar:  OK  
(1 - aqa ---)  
--- opya

Evet Hayır



AR

صندوق المستند:  OK  
01 صن. عنوان فرعي  
02 صندوق استقدام  
03 صندوق المهام



صندوق المهام:  OK  
01 خاصة/مخزنة  
ن. تجريبية/سريعة

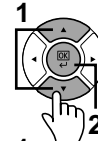

خاصة/مخزنة:  OK  
User 01  
User 02  
User 03



User: 01:  OK  
Data 01   
Data 02   
Data 03   
قائمة حدد

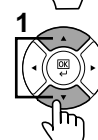

User: 01:  OK  
01 طباعة  
حذف

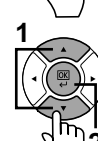

النسخ:  OK  
(1 - aqa ---)  
--- نسخ

نعم لا



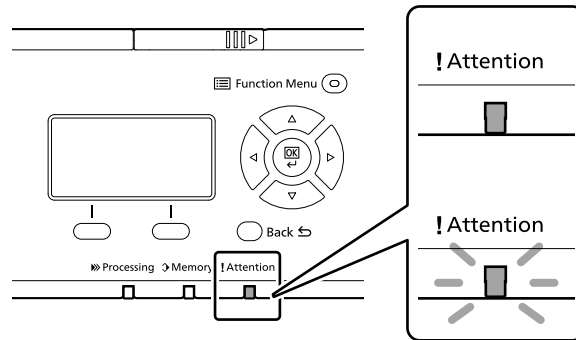

- EN** If an error occurs on the machine, the error message appears on the screen. Also the Attention indicator on the operation panel will light up or flash. Refer to the Operation Guide to Clear the error. For details, refer to the Operation Guide on the Product Library disc.
- CA** Si es produeix un error en el dispositiu, es mostrarà el missatge d'error a la pantalla. També s'il·luminarà o parpellejarà l'indicador "Attention" (Alerta) al tauler d'operacions. Consulteu la Guia de funcionament per esborrar l'error. Per obtenir més informació, consulteu la Manual d'instruccions al disc Biblioteca del producte.
- CS** Pokud v zařízení dojde k chybě, na obrazovce se objeví chybové hlášení. Indikátor Attention na ovládacím panelu se rozsvítí nebo bude blikat. Pro odstranění chyby se řiďte návodem k obsluze na disku Product Library.
- DA** Hvis der opstår fejl på maskinen, vises fejlmeddelelsen på skærmen. Samtidig vil Attention-lampen på betjeningspanelet lyse eller blinke. Se betjeningsguiden for at slette fejlen. Se Betjeningsvejledning på Product Library disken for yderligere information.
- DE** Falls ein Gerätefehler auftritt, erscheint eine Fehlermeldung in der Anzeige. Außerdem leuchtet oder blinkt die LED "Warnung" auf dem Bedienfeld. Lesen Sie in der Bedienungsanleitung nach, um den Fehler zu beseitigen. Weitere Details finden Sie in der Bedienungsanleitung auf dem Product Library Datenträger.
- EL** Αν πραγματοποιηθεί σφάλμα στο μηχάνημα, το μήνυμα του σφάλματος εμφανίζεται στην οθόνη. Επίσης, η ενδεικτική λυχνία Attention στον Πίνακα Λειτουργίας θα ανάψει ή θα αναβοσβήσει. Ανατρέξτε στο Εγχειρίδιο Χρήσης για να διορθώσετε το σφάλμα. Για λεπτομέρειες, ανατρέξτε στο Εγχειρίδιο Χρήσης στον δίσκο Product Library.
- ES** Si se produce un error en la máquina, el mensaje de error aparecerá en la pantalla. Además, el indicador Atención del panel de controles se iluminará o parpadeará. Consulte la Guía de uso para borrar el error. Para obtener más información, consulte la Guía de uso que está disponible en el disco Product Library.
- FI** Jos koneessa on vikatila, ruudulle ilmestyy vikailmoitus. Myös toimintapaneelin Attention -indikaattori syttyy tai vilkkuu. Katso Toimintaoppaasta, kuinka vikatila poistetaan. Löydät yksityiskohtaiset tiedot Tuotekirjastolevyn Käyttöopas.
- FR** Si une erreur se produit sur la machine, le message d'erreur s'affiche sur l'écran. De plus, le voyant Attention s'allume ou clignote sur le panneau de commande. Se reporter au manuel d'utilisation pour effacer l'erreur. Pour plus de détails, se reporter au manuel d'utilisation sur le disque Product Library.
- HU** Ha hiba történik a készüléken, egy hibaüzenet jelenik meg a képernyőn. Emellett az Attention jelzőfény is világít vagy villog a kezelőpanelen. A hiba megszüntetéséhez lásd a használati útmutatót. Részletekért lásd a Product Library lemezen lévő Használati útmutatót.
- IT** Se sulla macchina si verifica un errore, sullo schermo viene visualizzato un messaggio di errore. Inoltre, l'indicatore Attenzione del pannello comandi si illumina oppure lampeggia. Per eliminare l'errore, consultare la Guida alle funzioni. Per i dettagli, vedere la Guida alle funzioni, reperibile sul disco Product Library.
- NL** Als er een fout optreedt op het apparaat, dan verschijnt de foutmelding op het scherm. Bovendien gaat ook het Opgelet-indicatorlampje op het bedieningspaneel branden of knipperen. Raadpleeg de Gebruikershandleiding om de fout te wissen. Voor meer informatie, raadpleeg de Gebruikershandleiding op de Product Library schijf.

- NO** Hvis det oppstår en feil på maskinen, vises feilmeldingen på skjermen. Også "Attention"-indikatoren på betjeningspanelet vil tennes eller begynne å blinke. Se brukerveiledningen for å fjerne feilen. For detaljer, se Operatørhåndbok i produktbiblioteket.
- PL** Jeżeli na urządzeniu wystąpi błąd, na wyświetlaczu zostanie wyświetlony komunikat o błędzie. Błąd jest sygnalizowany też zaświeceniem się lub miganiem wskaźnika Attention na panelu operacyjnym. Aby skasować błąd, postępuj zgodnie z instrukcją obsługi. Więcej informacji można znaleźć w Podręcznik obsługi znajdującej się na dysku Product Library.
- PT-BR** Se ocorrer um erro na máquina, a mensagem de erro aparece na tela. Também o indicador Atenção no painel de operação vai acender ou piscar. Consulte o Guia de Operação para corrigir o erro. Para obter detalhes, consulte o Guia de Operação no disco Biblioteca do Produto.
- PT-PT** Se ocorrer um erro na máquina, a mensagem de erro surge no ecrã. Além disso, o indicador "Atenção" no painel de operações irá acender ou piscar. Consulte o Guia de Funcionamento para Limpar o erro. Para mais informações consulte o Guia de Uso no disco da Biblioteca de Produtos.
- RO** Dacă apare eroare la aparat, mesajul de eroare apare pe ecran. De asemenea, indicatorul Attention de pe panoul de operare se va lumina sau va clipi. Consultați Ghidul de Operare pentru a rezolva eroarea. Pentru detalii, consultați Ghid de operare de pe discul Product Library.
- RU** Если в работе аппарата произошла ошибка, на экране появится сообщение об ошибке. Также будет светиться или мигать индикатор Внимание на панели управления. По поводу сброса ошибки см. руководство по эксплуатации. Дополнительная информация приведена в Руководстве по эксплуатации на диске Product Library.
- SV** Om ett fel uppstår på maskinen, visas felmeddelandet på skärmen. Även "Attention"-indikatorn på kontrollpanelen tänds eller blinkar. Hänvisning ges till användarmanualen för information om hur man tar bort felet. För ytterligare detaljer, konsultera Bruksanvisning som finns på skivan Product Library.
- TR** Makinede bir hata meydana gelirse, hata mesajı ekranda görüntülenir. Ayrıca çalıştırma panelindeki Attention göstergesi yanıp söner veya yanık kalır. Hatayı temizlemek için Çalıştırma Kılavuzuna bakın. Ayrıntılar için, Product Library DVD'sindeki Çalıştırma Kılavuzuna bakınız.
- AR** في حالة حدوث خطأ في الجهاز، تظهر رسالة الخطأ على الشاشة، وكذلك يضيء مؤشر Attention على لوحة التشغيل أو يومض. راجع دليل التشغيل للتخلص من الخطأ. للحصول على تفاصيل، راجع دليل التشغيل على قرص Product Library.

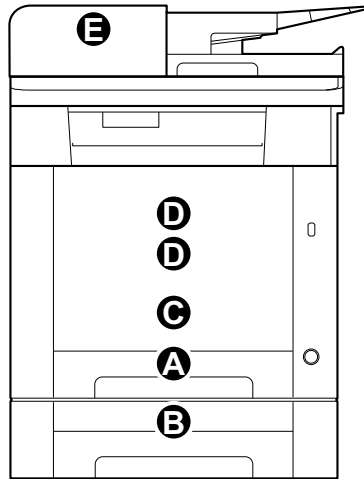
**S****Clear Paper Jam****A**

①

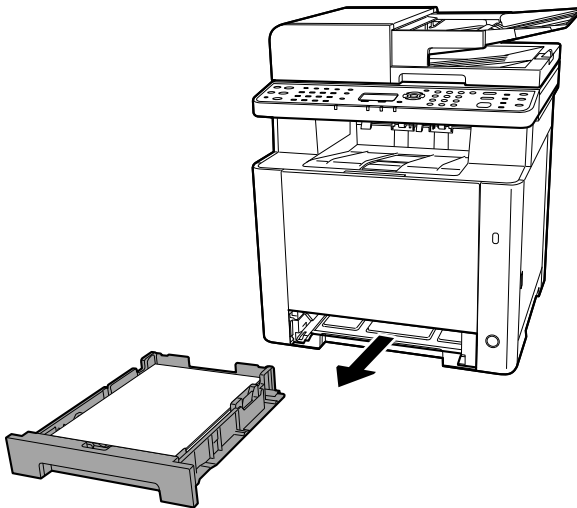

②

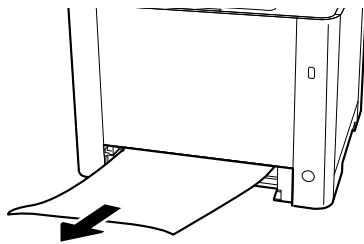

③

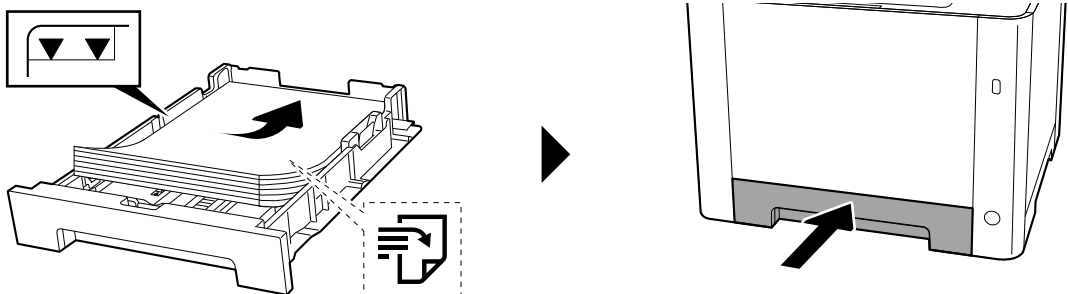

**B**

①

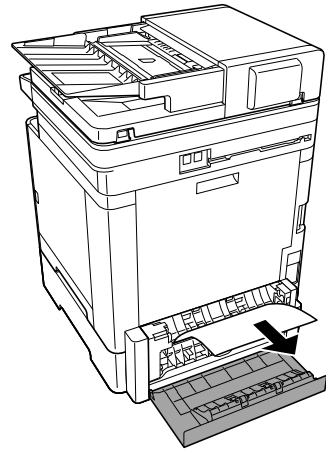
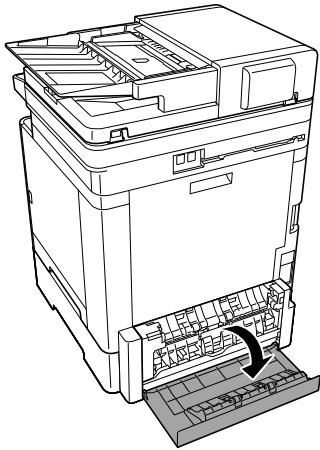

②

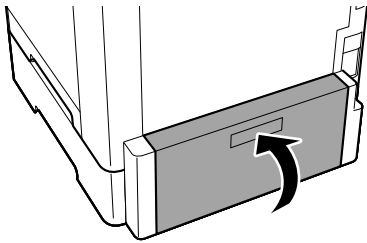

③

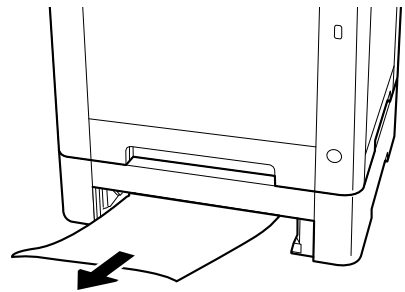
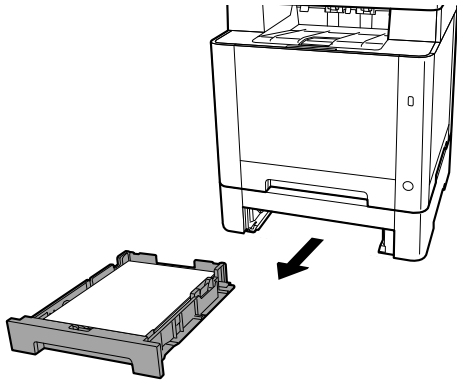

④

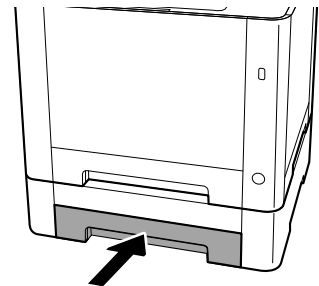
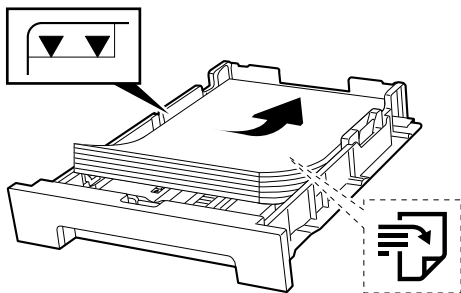

**C**

①

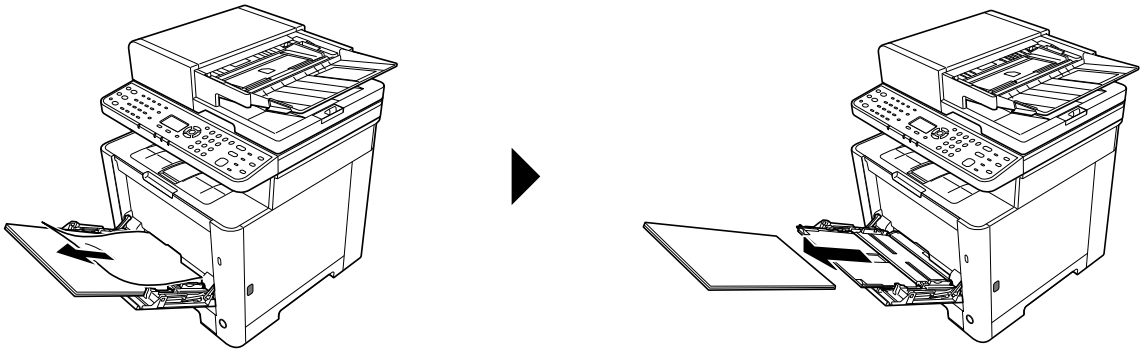

②

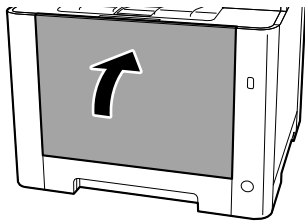

③

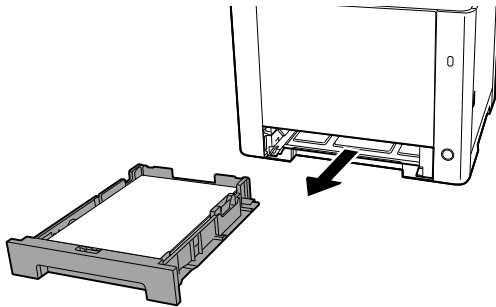

④

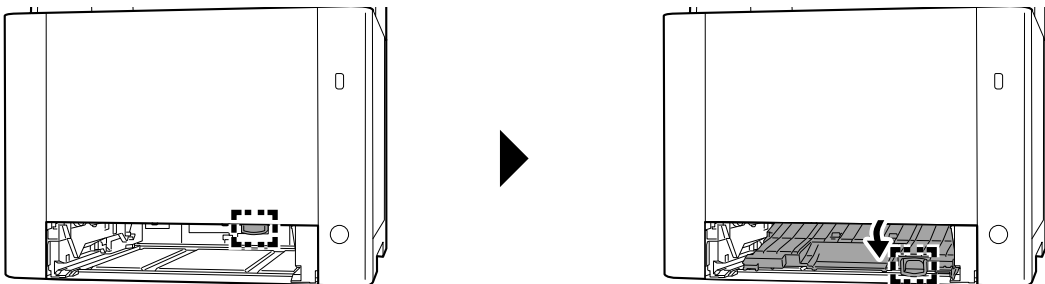

5

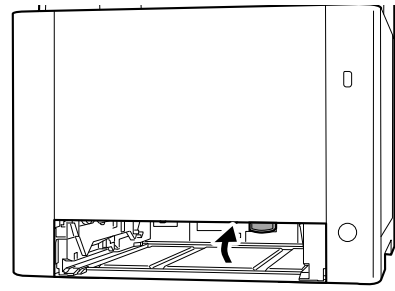
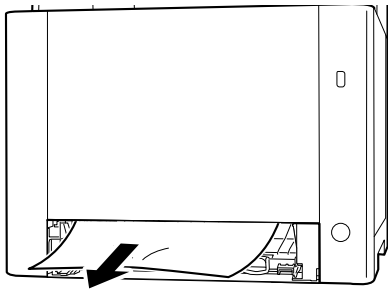

6

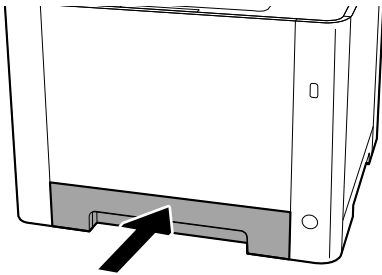

7

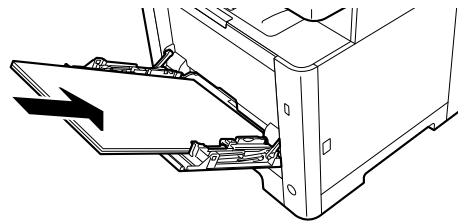
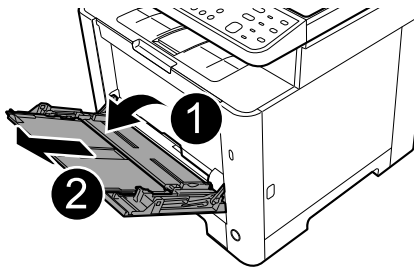



**D**

①

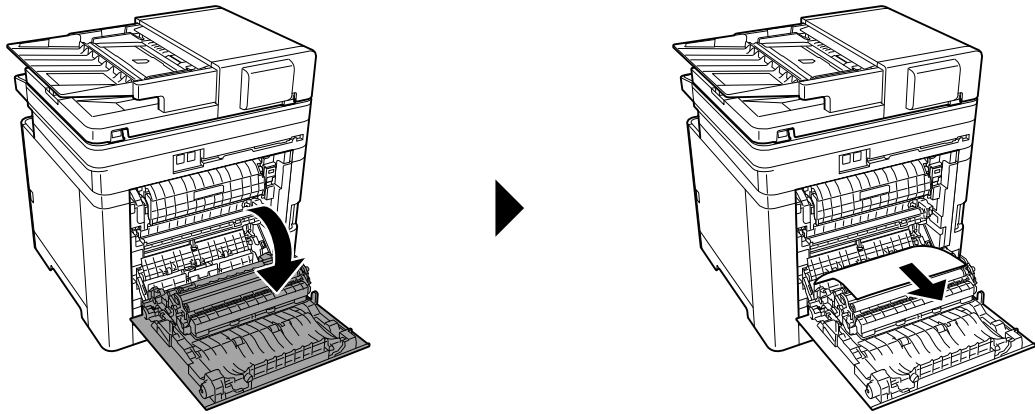

②

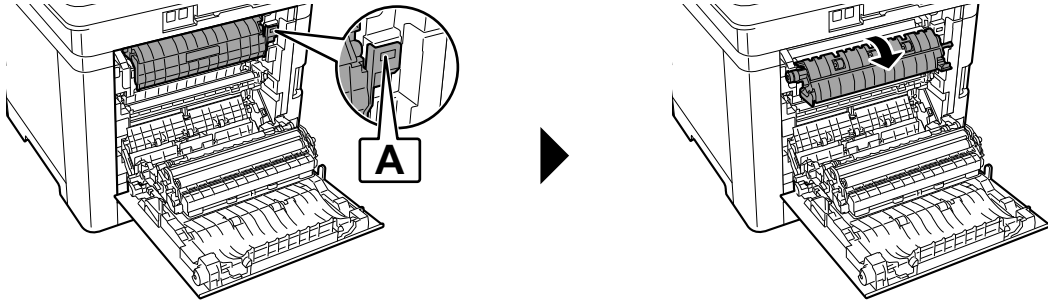

③

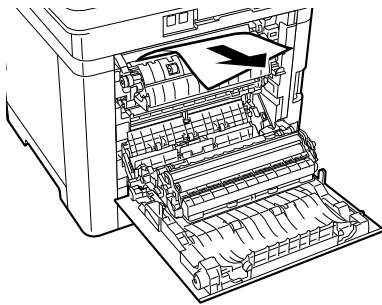

④

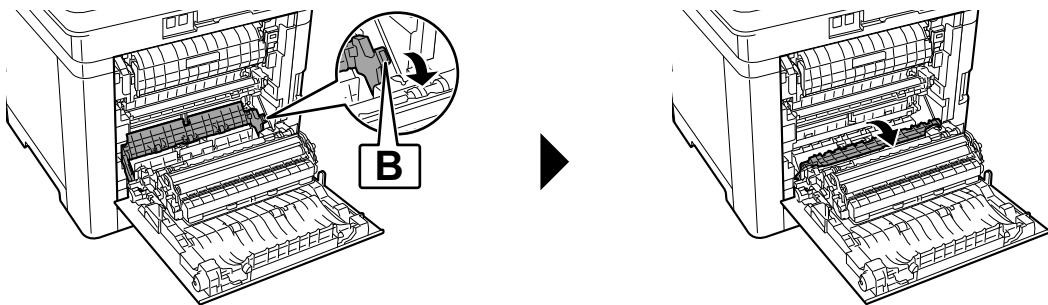

5

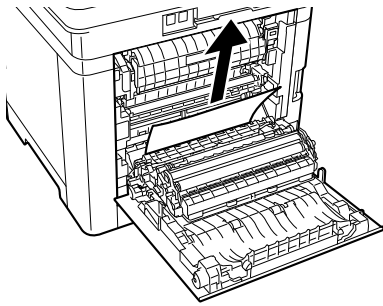

6

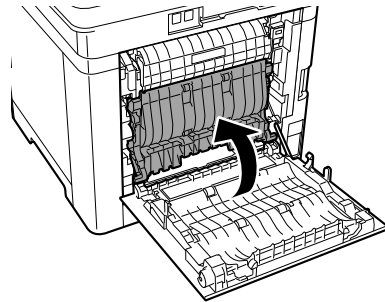
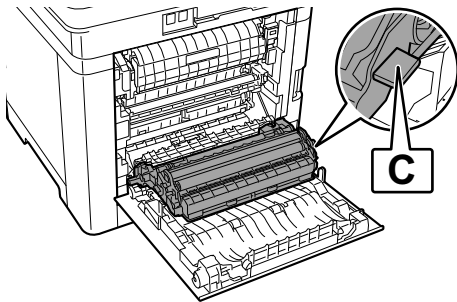

7

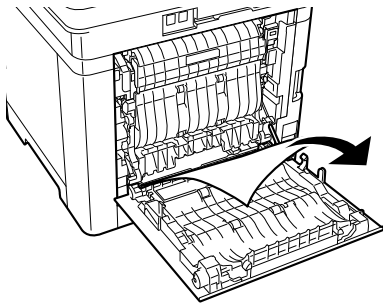

8

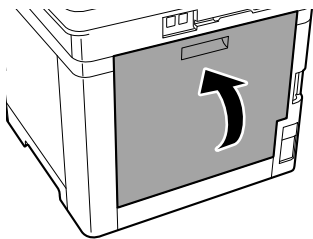

**E**

①

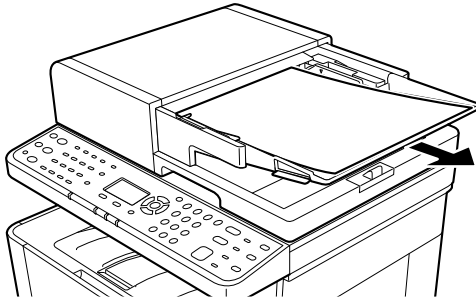

②

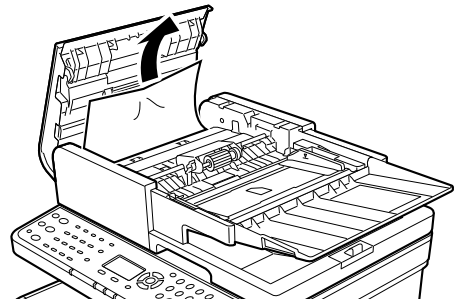
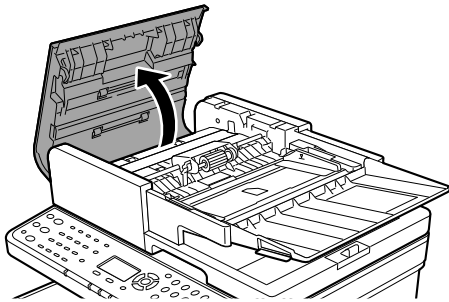

③

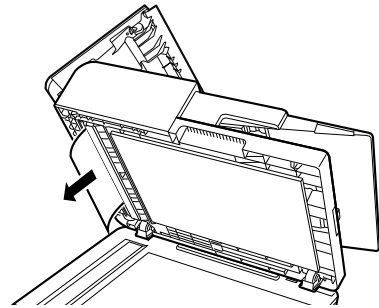
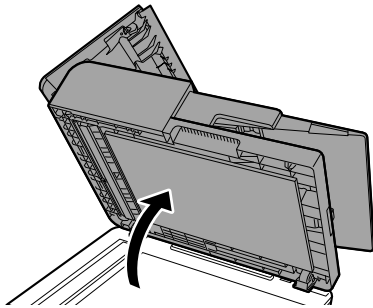

④

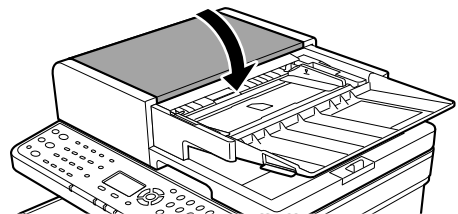
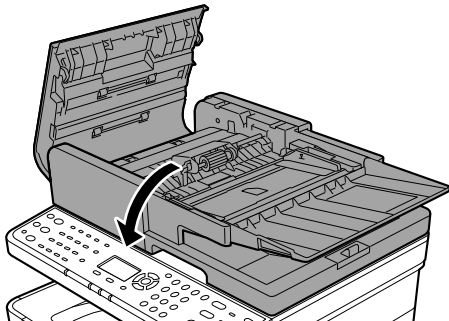

MEMO

MEMO

MEMO



**QUALITY  
CERTIFICATE**

This machine has passed  
all quality controls and  
final inspection.

